

Installation advices - Instructions for the use



BUILT-IN ELECTRIC OVENS

**100% ELBA QUALITY
MADE IN ITALY**



ELBA
TALENT FOR COOKING



Made in Italy

Dear Customer,

Thank you for having purchased and given your preference to our product. The safety precautions and recommendations within this booklet are for your own safety and that of others. They will also provide a means by which to make full use of the features offered by your appliance.

Please preserve this booklet carefully. It may be useful in future, either to yourself or to others in the event that doubts should arise relating to its operation.

This appliance must be used only for the task it has explicitly been designed for, that is for cooking foodstuffs. Any other form of usage is to be considered as inappropriate and therefore dangerous.

The manufacturer declines all responsibility in the event of damage caused by improper, incorrect or illogical use of the appliance.

DECLARATION OF CE CONFORMITY

- This appliance has been designed to be used only for cooking. Any other use (such as heating a room) is improper and dangerous.
- This appliance has been designed, constructed, and marketed in compliance with:
 - Safety requirements of the “Low voltage” Directive 2014/35/EU;
 - Safety requirements of the “EMC” Directive 2014/30/EU;
 - Requirements of EU Directive 93/68/EEC;
 - Requirements of EU Directive 2011/65/EU.



IMPORTANT INFORMATION FOR CORRECT DISPOSAL OF THE PRODUCT IN ACCORDANCE WITH EC DIRECTIVE 2012/19/EC.

At the end of its working life, the product must not be disposed of as urban waste. It must be taken to a special local authority differentiated waste collection centre or to a dealer providing this service.

Disposing of a household appliance separately avoids possible negative consequences for the environment and health deriving from inappropriate disposal and enables the constituent materials to be recovered to obtain significant savings in energy and resources. As a reminder of the need to dispose of household appliances separately, the product is marked with a crossed-out wheeled dustbin.



IMPORTANT SAFETY PRECAUTIONS AND RECOMMENDATIONS

IMPORTANT: This appliance is designed and manufactured solely for the cooking of domestic (household) food and is not suitable for any non domestic application and therefore should not be used in a commercial environment.

The appliance guarantee will be void if the appliance is used within a non domestic environment i.e. a semi commercial, commercial or communal environment.

Read the instructions carefully before installing and using the appliance.

- This appliance has been designed and manufactured in compliance with the applicable standards for the household cooking products and it fulfills all the safety requirements shown in this manual, including those for surface temperatures. Some people with sensitive skin may have a more pronounced temperature perception with some components although these parts are within the limits allowed by the norms. The complete safety of the appliance also depends on the correct use, we therefore recommend to always pay a extreme attention while using the product, especially in the presence of children.
- After having unpacked the appliance, check to ensure that it is not damaged and that the oven door closes correctly. In case of doubt, do not use it and consult your supplier or a professionally qualified technician.
- Packing elements (i.e. plastic bags, polystyrene foam, nails, packing straps, etc.) should not be left around within easy reach of children, as these may cause serious injuries.
- Some appliances are supplied with a protective film on steel and aluminium parts. **This film must be removed before using the appliance.**
- **IMPORTANT:** The use of suitable protective clothing/gloves is recommended when handling or cleaning this appliance.

- Do not attempt to modify the technical characteristics of the appliance as this may become dangerous to use. The manufacturer declines all responsibility for any inconvenience resulting from the inobservance of this condition.
- Do not operate your appliance by means of an external timer or separate remote-control system.
- Do not carry out cleaning or maintenance operations on the appliance without having previously disconnected it from the electric power supply.
- **WARNING:** Ensure that the appliance is switched off before replacing the oven lamp to avoid the possibility of electric shock.
- Do not use a steam cleaner because the moisture can get into the appliance therefore making it unsafe.
- Do not touch the appliance with wet or damp hands (or feet).
- Do not use the appliance whilst in bare feet.
- If you should decide not to use this appliance any longer (or decide to substitute another model), before disposing of it, it is recommended that it be made inoperative in an appropriate manner in accordance to health and environmental protection regulations, ensuring in particular that all potentially hazardous parts be made harmless, especially in relation to children who could play with unused appliances.
- The various components of the appliance are recyclable. Dispose of them in accordance with the regulations in force in your country. If the appliance is to be scrapped, remove the power cord.
- After use, ensure that the knobs/controls are in the off position.
- Children less than 8 years of age shall be kept away unless continuously supervised.
- This appliance can be used by children aged from 8 years and above and persons with reduced physical, sensory or mental capabilities or lack of experience and knowledge if they have been given supervision or instruction concerning use of the appliance in a safe way and understand the hazards involved. Children shall not play with the appliance. Cleaning and user maintenance shall not be made by children without supervision.

- The manufacturer declines all liability for injury to persons or damage to property caused by incorrect or improper use of the appliance.
- **WARNING:** During use the appliance and its accessible parts become hot; they remain hot for some time after use.
 - Care should be taken to avoid touching heating elements inside the oven.
 - The door is hot, use the handle.
 - To avoid burns and scalds, young children should be kept away.
- Make sure that electrical cables connecting other appliances in the proximity of the oven cannot become entrapped in the oven door.
- **WARNING:** When correctly installed, your product meets all safety requirements laid down for this type of product category. However special care should be taken around the rear or the underneath of the appliance as these areas are not designed or intended to be touched and may contain sharp or rough edges, that may cause injury.
- **FIRST USE OF THE OVEN** - it is advised to follow these instructions:
 - Furnish the interior of the oven as described in the chapter “CLEANING AND MAINTENANCE”.
 - Switch on the empty oven on max to eliminate grease from the heating elements.
 - Disconnect the appliance from the electrical power supply, let the oven cool down and clean the interior of the oven with a cloth soaked in water and neutral detergent; then dry carefully.
- **CAUTION:** Do not use harsh abrasive cleaners or sharp metal scrapers to clean the oven door glass since they can scratch the surface, which may result in shattering of the glass.
- Do not line the oven walls or floor with aluminium foil. Do not place baking trays or the drip tray on the base of the oven chamber.
- **FIRE RISK!** Do not store flammable material in the oven.

- Always use oven gloves when removing the shelves and food trays from the oven whilst hot.
- Do not hang towels, dishcloths or other items on the appliance or its handle – as this could be a fire hazard.
- Clean the oven regularly and do not allow fat or oils to build up in the oven base or tray. Remove spillages as soon as they occur.
- Do not stand on the open oven door.
- Always stand back from the appliance when opening the oven door to allow steam and hot air to escape before removing the food.
- **SAFE FOOD HANDLING:** Leave food in the oven for as short a time as possible before and after cooking. This is to avoid contamination by organisms which may cause food poisoning. Take particular care during warmer weather.
- **WARNING:** Take care NOT to lift the appliance by the door handle.
- The appliance must not be installed behind a decorative door in order to avoid overheating.
- The oven accessories (e.g. oven wire rack) must be fitted correctly as indicated at page 53 - 54.
- **IMPORTANT NOTE:** The oven shelves (for some products one shelf only is provided) have not been designed to place the food directly on the shelf itself. When cooking, always place the food in special containers or use specific materials suitable for the food contact.
- If the power supply cable is damaged, it must be replaced only by an authorized service agent in order to avoid a hazard.
- If the appliance is not fitted with a supply cord and a plug, or with other means for disconnection from the supply mains having a contact separation in all poles that provide full disconnection under overvoltage category III conditions, means for disconnection must be incorporated in the fixed wiring in accordance with the wiring rules.
- **WARNING:** The appliance and its accessible parts become hot during use.
Care should be taken to avoid touching heating elements.
Children less than 8 years of age shall be kept away unless continuously supervised.

ENERGY LABELLING/ECODESIGN

- Commission delegated regulation (EU) No 65/2014 (supplementing Directive 2010/30/EU of the European Parliament and of the Council).
- Commission regulation (EU) No 66/2014 (implementing Directive 2009/125/EC of the European Parliament and of the Council).

Reference to the measurement and calculation methods used to establish compliance with the above requirements:

- Standard EN 60350-1 (electric ovens).

USE OF THE APPLIANCE, ENERGY SAVING TIPS

OVEN

- Check the oven door always closes properly and the door gasket is clean and in order. During use, open the oven door only when strictly necessary to avoid heat losses (for some functions it may be necessary to use the oven with the door half-closed, check the oven operating instructions).
- Turn off the oven 5-10 minutes before the end of the theoretical cooking time to recuperate the stored heat.
- We recommend using oven proof dishes and adjusting the oven temperature during cooking if necessary.

Advice for the installer

1

INSTALLATION

IMPORTANT:

- The appliance is designed and approved for domestic use only and should not be installed in a commercial, semi commercial or communal environment.
Your product will not be guaranteed if installed in any of the above environments and could affect any third party or public liability insurances you may have.
- This appliance is to be installed only by an authorised person according to the current local regulations and in observation of the manufacturer's instructions. Failure to comply with this condition will render the guarantee invalid.
- Incorrect installation, for which the manufacturer accepts no responsibility, may cause personal injury or damage.
- This appliance shall only be serviced by authorized personnel.
- Always disconnect the appliance from mains power supply before carrying out any maintenance operations or repairs.
- Some appliances are supplied with a protective film on steel and aluminium parts. This film must be removed before using the appliances.
- **Important: The use of suitable protective clothing/gloves is recommended when handling or installing this appliance.**
- **The appliance must be housed in heat resistant units.**
- **The walls of the units must be capable of resisting temperatures of 70 °C above room temperature.**
- **We would point out that the adhesive which bonds the plastic laminate to the furniture must withstand temperatures not less than 150 °C to avoid delamination.**
- **Do not install the appliance near inflammable materials (eg. curtains).**

WARNING!

When correctly installed, your product meets all safety requirements laid down for this type of product category.

However special care should be taken around the rear or the underneath of the appliance as these areas are not designed or intended to be touched and may contain sharp or rough edges, that may cause injury.

IMPORTANT

- The oven can be fitted in standard units, width and depth 60 cm.
- Installation requires a compartment as illustrated in figures 1.1 and 1.2. On the lower side, the oven must lay on supports standing the oven weight.
- Remember the housing should not be free standing but be secured to the wall and/or adjacent fittings.
- **Do not seal the oven into the cabinetry with silicone or glue; this makes future servicing difficult. The manufacturer will not cover the costs of removing the oven, or of damage caused by this removal.**
- **Caution! Do not lift this oven by the door handle.**

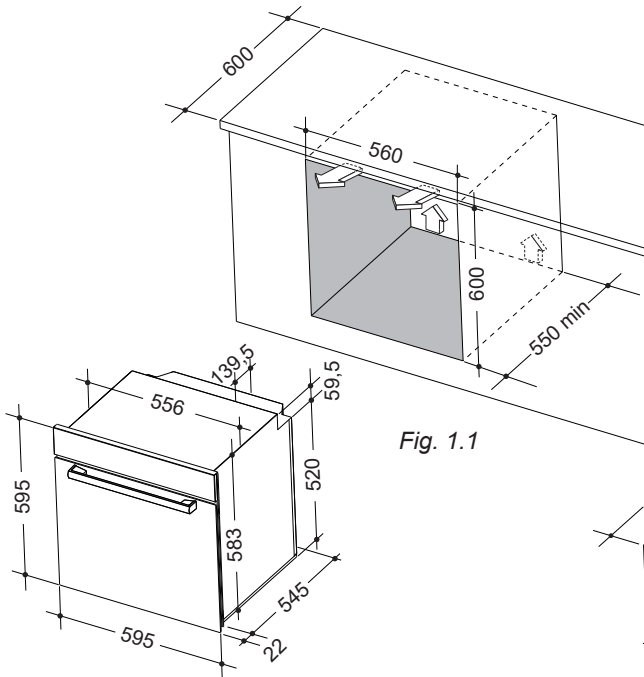

Fig. 1.1

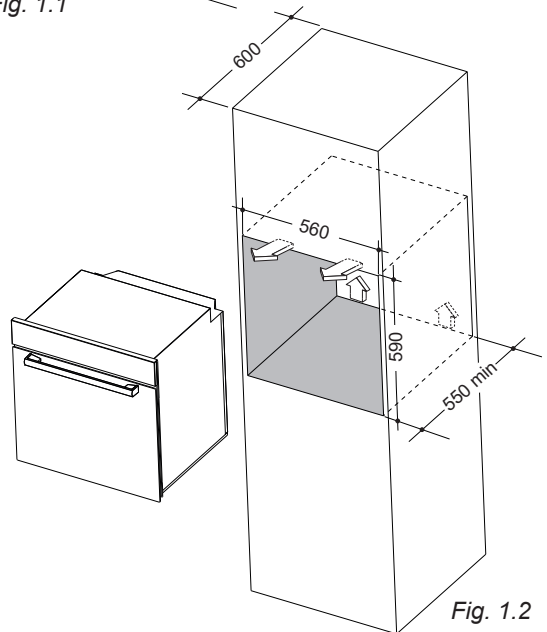
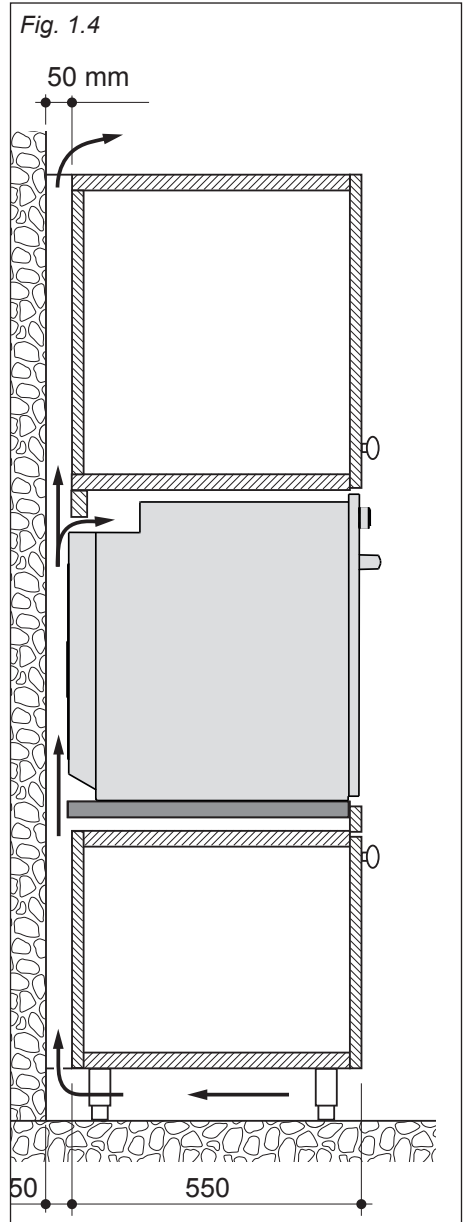
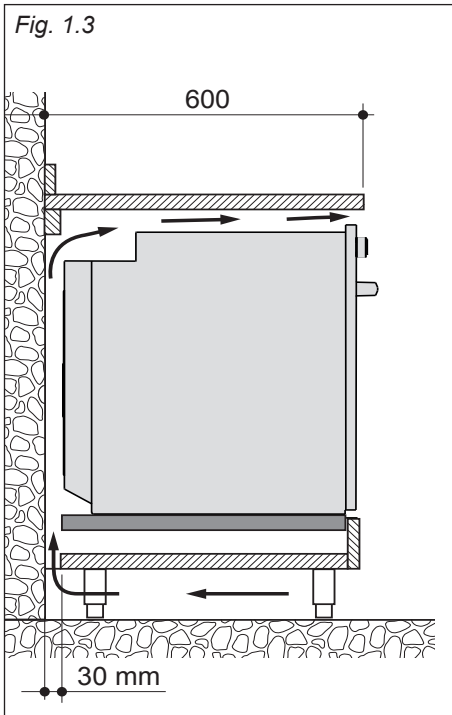

Fig. 1.2

To ensure internal ventilation, aeration channels must be provided as illustrated in the figures 1.3 and 1.4.



FIXING THE OVEN

Introduce the oven into the furniture opening and fix it with 2 screws (not supplied) as figure 1.5.

It is essential that the oven rests on a surface which will support its weight, as the screw fixing is only complementary.

Note:

It is essential that when installing your oven adequate air circulation is allowed for within the installation. See figures 1.1, 1.2, 1.3 and 1.4.

Inadequate air circulation may greatly impair the performance of your oven and may effect adjacent cabinets due to an increase in temperature.

Caution! Do not lift this oven by the door handle.

Adjust the hinges of furniture doors adjacent to the oven to allow a 4-5 mm gap between the furniture door and the oven frame.

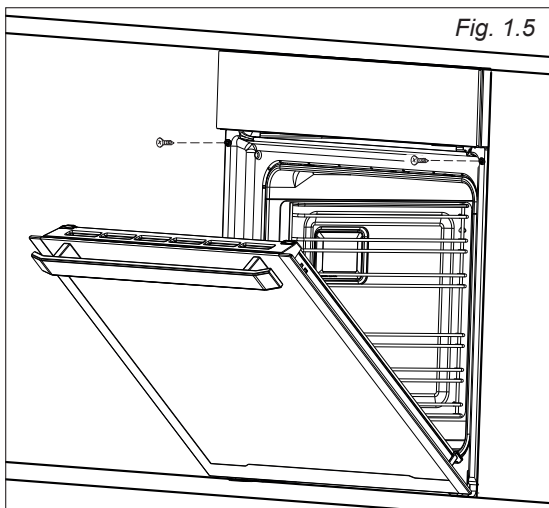

IMPORTANT (only for some models): When handling the oven, take care not to damage the door sensor lever "L" (fig. 1.6) (near the top left corner of the oven seal).

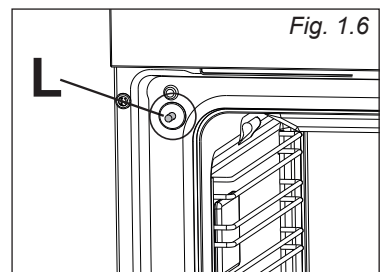

2

ELECTRICAL SECTION

IMPORTANT: The appliance must be installed by a qualified technician according with the current local regulations and in compliance with the manufacturer instructions. Incorrect installation may cause harm and damage to people, animals or property, for which the manufacturer accepts no responsibility.

GENERAL

- The connection to the electrical network must be carried out by qualified personnel and must be according to existing norms.
- The appliance must be connected to the electrical network verifying above all that the voltage corresponds to the value indicated on the specifications plate and that the cables section of the electrical plant can bear the load which is also indicated on the plate.
- If the appliance is supplied without a power supply plug and if you are not connecting directly to the mains, a standardized plug suitable for the load must be fitted.
- The colours of the wires in the appliance power cable may not correspond with the colours marked on the terminals of your electrical plug. The plug should always be wired as follows:
 - connect the green/yellow wire to the terminal marked with the letter “E” or the earth symbol \perp or coloured green/yellow;
 - connect the blue wire to the terminal marked with the letter “N” or coloured black;
 - connect the brown wire to the terminal marked with the letter “L” or coloured red.

Before effecting any intervention on the electrical parts of the appliance, the connection to the network must be interrupted.

- The bi-polar plug must be connected to an outlet connected to the grounding unit in conformity to security norms.
- If the oven is to be connected directly to the mains, it must be placed with an omnipolar switch with minimum opening between the contacts of 3 mm between the appliance and the mains.
- The power supply cable must not touch the hot parts and must be positioned so that it does not exceed 50°C at any point.
- Once the oven has been installed, the switch or socket must always be accessible.
- If the power supply cable is damaged it must be substituted by a suitable cable available in the after sales service.

N.B. For connection to the mains, do not use adapters, reducers or branching devices as they can cause overheating and burning.

If the installation requires alterations to the domestic electrical system call an expert. He should also check that the domestic electrical system is suitable for the power absorbed by the appliance.

The connection of the appliance to the grounding unit is mandatory. The manufacturer declines every responsibility for any inconvenience resulting from the inobservance of this condition.

CONNECTION OF THE POWER SUPPLY CABLE

WARNING: If the power supply cable is damaged, it must be replaced only by an authorised service agent in order to avoid a hazard.

NOTE: The earth conductor must be left about 3 cm longer than the others.
The operations must be executed by a qualified technician.

FEEDER CABLE SPECIFICATIONS

“TYPE H05VV-F or H05V2V2-F (resistance to temperatures of 90°C)”

220-240 V ac 3 x 1,5 mm² (*)

(*) Connection possible with plug and outlet

User guide

USING THE PRESS-AND-TURN CONTROL KNOBS (SOME MODELS ONLY)

The control knobs are flush-mounted in the control panel.

Use them as follows:

- a. Press lightly on the knob (figure A);
- b. The knob will extend outwards as illustrated in figure B.
- c. Turn the knob to the required position (figure C).
- d. When you have finished cooking, turn the knob back to the "0", "O" or "□" (off) position and press it (figure D) so that it stays flush with the control panel again (figure F).

IMPORTANT:

Never press down the knob when it is not in the "0", "O" or "□" (off) position (figure E).

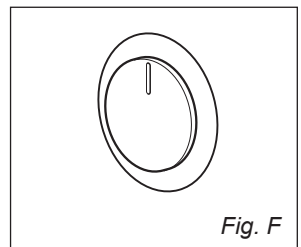
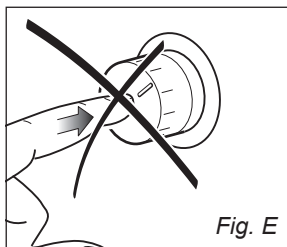
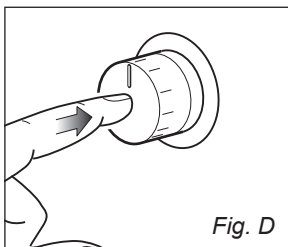
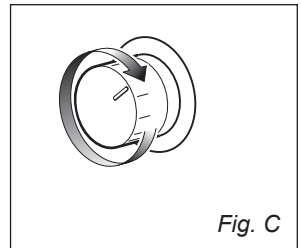
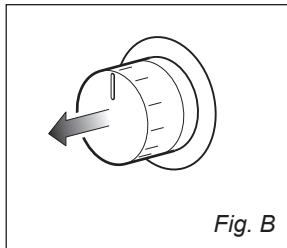
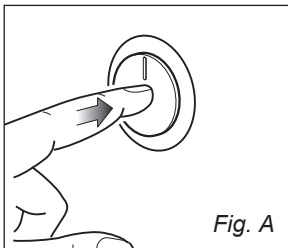

1 CONTROL PANELS

Fig. 1.1

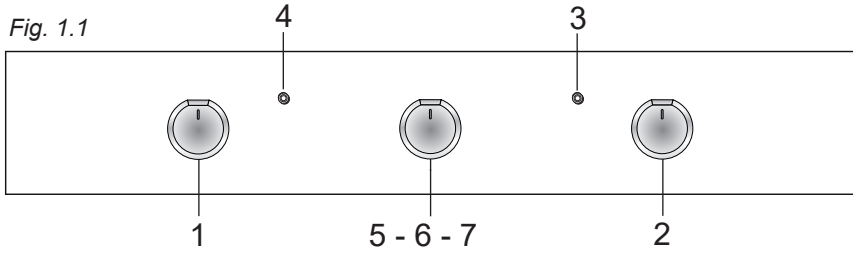

Fig. 1.2

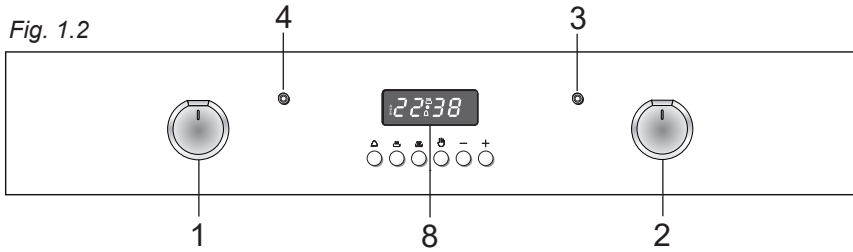

Fig. 1.3

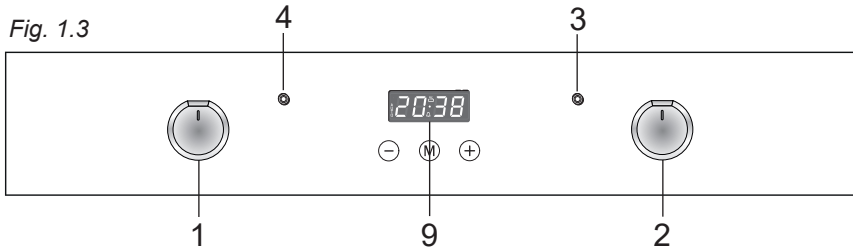

Fig. 1.4

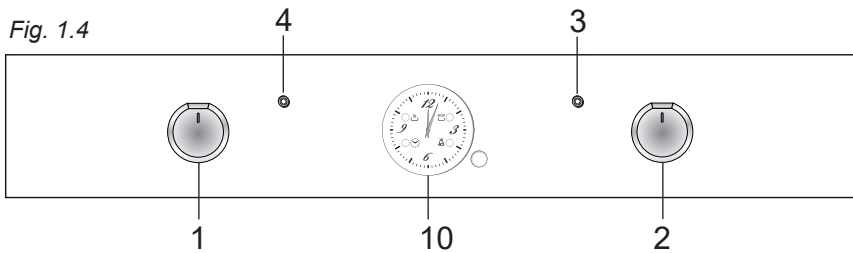
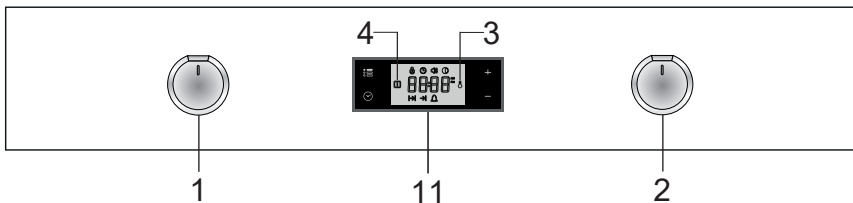

Fig. 1.5



CONTROLS DESCRIPTION

1. Function selector control knob
2. Oven temperature control knob
3. Oven temperature indicator light
4. Power on indicator light
5. 60 minutes alarm
6. 120 minutes alarm
7. Timer (120 minutes cut-off)
8. Electronic clock/programmer
9. Clock and timer with "Touch-Control" keys
10. Electric clock/programmer
11. Electronic clock/programmer "Touch-controls"

**NOTES: The knob and symbols may vary.
The symbols may be printed on the knob
itself.**

Please note: Your appliance has been fitted with a cooling fan to achieve optimum efficiency of the controls and to ensure lower surface temperatures are maintained. The cooling fan motor switches ON/OFF depending on temperature. Depending on cooking temperatures and times, the cooling fan may run on even after the appliance oven has been switched off. The duration of this time is dependent on previous cooking temperature and duration.

2 HOW TO USE THE OVEN

Attention: The oven door becomes very hot during operation. Keep children away.

WARNING:
The door is hot, use the handle.

During use the appliance becomes hot. Care should be taken to avoid touching heating elements inside the oven.

Do not line the oven walls or floor with aluminium foil. Do not place baking trays or the drip tray on the base of the oven chamber.

RISK OF IRREPARABLE DAMAGE TO THE ENAMEL.



THERMOSTAT CONTROL KNOB

To turn on the heating elements of the oven, set function selector knob to the required position and the thermostat knob to the desired temperature.

To set the temperature, line up the temperature knob indicator with the required temperature.

The elements will turn on or off automatically which is determined by the thermostat. The operation of the heating elements is signalled by a light placed on the control panel.

NOTE: When using the oven for the first time, in order to eliminate any traces of substances or odours left over from the production process, switch the oven on and run it empty (without the accessories, which should be washed separately), keeping the installation environment sufficiently ventilated:





- for 60 minutes in the position  (thermostat in position 250°C);
- for 30 minutes in the position  (thermostat in position 250°C);
- for 15 minutes in the position  (thermostat in position 225°C).





Note: depending on model, only some of these functions may be available.



When the oven has cooled down completely, unplug it from the mains power socket and clean inside it as described in "CLEANING AND MAINTENANCE".

NOTE: The symbols shown in this section are for guidance only and represent the primary function.

Depending on your model, your oven may only have some of these functions.
For best results, always preheat the oven.



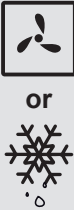





FUNCTION	NAME OF THE FUNCTION	DESCRIPTION OF THE FUNCTION
	OVEN LIGHT	By turning the function selector knob to this setting, the oven light/s will illuminate in the oven cavity. The oven light/s will operate on all selected functions.
	TRADITIONAL CONVECTION COOKING	The upper and lower heating elements are switched on. The heat is diffused by natural convection and the temperature must be regulated between the minimum and the maximum position with the thermostat knob. Recommended for: For foods which require the same cooking temperature both internally and externally, i. e. roasts, spare ribs, meringue, etc.
	CONVECTION COOKING WITH VENTILATION	The upper and lower heating elements and the fan motor are switched on. The heat coming from the top and bottom is diffused by forced convection. The temperature must be regulated between the minimum and the maximum position with the thermostat knob. Recommended for: For foods of large volume and quantity which require the same internal and external degree of cooking; for ex: rolled roasts, turkey, legs, cakes, etc.
	LOWER HEATING ELEMENT	In this position only the lower heating element is switched on. Heat is distributed by natural convection. The temperature must be regulated between the minimum and 250°C maximum. Recommended for: To complete cooking of dishes that require higher temperature at the bottom.

	<p>LOWER HEATING ELEMENT WITH VENTILATION</p>	<p>The lower heating element and the fan motor are switched on. The heat coming from the bottom is diffused by forced convection. The temperature must be regulated between the minimum and 250°C maximum with the thermostat knob.</p> <p>Recommended for: To complete cooking of dishes that require higher temperature at the bottom.</p>
	<p>UPPER HEATING ELEMENT</p>	<p>In this position only the upper heating element is switched on. Heat is distributed by natural convection. The temperature must be regulated between the minimum and the maximum position with the thermostat knob.</p> <p>Recommended for: To complete cooking of dishes that require higher temperature at the top.</p>
	<p>TRADITIONAL GRILLING</p>	<p>The infrared heating element is switched on. The heat is diffused by radiation. Use with the oven door closed and the thermostat knob must be regulated between the minimum and 225°C maximum. For correct use see chapter "USE OF THE GRILL".</p> <p>Recommended for: Grilling action for cooking with the broiler; browning, crisping, "au gratin", toasting, etc.</p>
	<p>DOUBLE GRILL COOKING</p>	<p>The infrared heating element and the upper heating element is switched on. The heat is diffused by radiation. Use with the oven door closed and the thermostat knob must be regulated between the minimum and 225°C maximum. For correct use see chapter "USE OF THE GRILL".</p> <p>Recommended for: Intense grilling action for cooking with the broiler; browning, crisping, "au gratin", toasting, etc.</p>
	<p>HOT AIR COOKING</p>	<p>The circular heating element and the fan motor are switched on. The heat is diffused by forced convection and the temperature must be regulated between the minimum and the maximum position with the thermostat knob.</p> <p>Recommended for: For foods that must be well done on the outside and tender or rare on the inside, i. e. lasagna, lamb, roast beef, whole fish, etc.</p>

	<p>VENTILATED DOUBLE GRILL COOKING</p>	<p>The infrared heating element, the upper heating element and the fan motor are switched on. The heat is mainly diffused by radiation and the fan then distributes it throughout the oven.</p> <p>Use with the oven door closed and the thermostat knob must be regulated between the minimum and 200°C maximum.</p> <p>It is necessary to preheat the oven for about 5 minutes. For correct use see chapter "GRILLING AND AU GRATIN".</p> <p>Recommended for: For grill cooking when a fast outside browning is necessary to keep the juices in, i. e. veal steak, steak, hamburger, etc.</p>
	<p>DEFROSTING FROZEN FOODS</p>	<p>Only the oven fan is switched on.</p> <p>To be used with the thermostat knob in the "●" (off) position because the other positions have no effect. The defrosting is done by simple ventilation without heat.</p> <p>Recommended for: To rapidly defrost frozen foods; 1 kilogram requires about one hour. The defrosting times vary according to the quantity and type of foods to be defrosted.</p>
	<p>HOT AIR COOKING WITH UPPER HEATING ELEMENT</p>	<p>The circular heating element, the fan motor and the upper heating elements are switched on. The heat is diffused by forced convection and the temperature must be regulated between the minimum and the maximum position with the thermostat knob.</p> <p>Recommended for: cooking of frozen products.</p> <p>This function can also be used for quick preheating. Set the thermostat knob to the desired temperature; when the pre-heating temperature has been reached, the oven temperature indicator light, placed on the control panel, switches off. You can then select the cooking function you want.</p>
	<p>HOT AIR COOKING WITH LOWER HEATING ELEMENT</p>	<p>The circular heating element, the fan motor and the lower heating elements are switched on. The temperature must be regulated between the minimum and the maximum position with the thermostat knob.</p> <p>Recommended for: Foods that need to be cooked with more heat underneath, e.g. pizza, quiche, etc.</p>

	<p>GENTLE COOKING</p>	<p>This function is particularly beneficial for the gentle cooking of small quantities of food on a single shelf. It is recommended to place the food on the first rack from the bottom.</p> <p>It is not necessary to preheat the oven and use with the oven door closed.</p> <p>Cooking times may be longer than standard functions. Do not use this function to preheat the oven.</p>
---	------------------------------	--

OPTIONAL ADDITIONAL FUNCTIONS TO THE PRIMARY FUNCTION

	<p>EASY STEAM</p>	<p>See chapter "EASY STEAM"</p>
	<p>IDROCLEAN</p>	<p>For the Idroclean function, see chapter "CLEANING AND MAINTENANCE"</p>
	<p>ROTISSERIE</p>	<p>See chapter "ROTISSERIE" and "USE OF THE ROTISSERIE"</p>
	<p>LEAVENING FUNCTION</p>	<p>See chapter "LEAVENING FUNCTION"</p>
	<p>REGENERATION - KEEPING FOOD WARM</p>	<p>See chapter "REGENERATION"</p>
	<p>PIZZA FUNCTION</p>	<p>See chapter "PIZZA FUNCTION"</p>
<p>≡ TURBO </p> <p>or</p> 	<p>TURBO / BOOSTER</p>	<p>This special function allows a fast pre-heating of the cavity.</p> <p>The circular heating element, the fan motor and the upper heating elements are switched on.</p> <p>Set the thermostat knob to the desired temperature; when the pre-heating temperature has been reached, the oven temperature indicator light, placed on the control panel, switches off. You can then select the cooking function you want.</p> <p>For optimum preheating, wait for at least 20 minutes before placing food in the oven.</p>

AIR FRY

AIR FRY

With the aid of the **Air Fry** function  it is possible to cook food in a healthy way, without adding oils and fats. The operation in combination with circular heating element, fan motor and upper heating element, allows to cook without added condiments, French fries, chicken wings, croquettes and other frozen or precooked foods. In addition, the special Air Fry enamelled tray (*) has a perforated surface so as to facilitate the entry of air, giving the dishes a tasty crispy effect (see dedicated section).

Recommended for: frozen and/or pre-cooked products. This function can also be used for quick preheating. See “OPTIONAL ADDITIONAL FUNCTIONS TO THE PRIMARY FUNCTION”, function “TURBO/BOOSTER”.

(*) Not all of the accessories/ovenware are included in the standard equipment.

EASY STEAM (certain models only)

By evaporating water inside the oven, the Easy Steam function helps make food soft on the inside and crisp on the outside.

1. With the oven cold, pour 250 ml of drinking water (or the quantities of water indicated in the cooking tables) into the circular well on the floor of the oven.
2. Place the food in the oven and activate the Easy Steam function.
Caution: never open the door or top up the water when cooking is in progress. Burns hazard!
3. At the end of the cooking process, open the door slowly and let the steam out.

Caution: to prevent the formation of lime-scale, you are advised to clean the bottom of the oven after each cooking cycle with Easy Steam, once the oven has cooled down completely.

You are also advised to wipe the condensation off the door glass with a soft cloth (see “CLEANING AND MAINTENANCE”).

Alternate Easy Steam cycles with conventional cooking cycles.

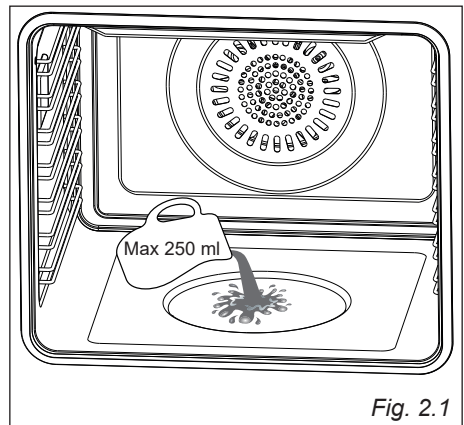



Fig. 2.1

ROTISSERIE (SOME MODELS ONLY)

This is used for spit roasting and comprises:

- an electrical motor mounted on the rear part of the oven;
- a stainless steel rod, equipped with a detachable athermic grip and 2 recordable forks;
- a rod support to be inserted into the central guides of the oven cavity.

The rotisserie motor is operated by switch the knob in the position  .

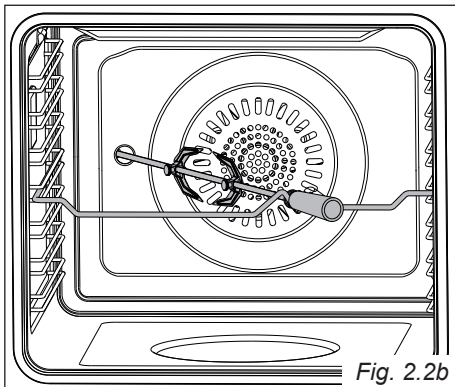
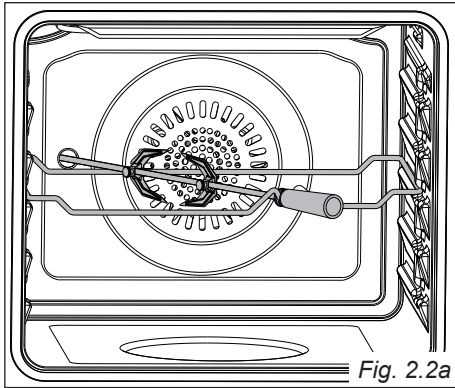

USE OF THE ROTISSERIE (fig. 2.2a, 2.2b)

- Insert the tray into the lowest rack holders of the oven and insert the rod support into the intermediate rack holders (fig. 2.2a, 2.2b).
- Put the meat to be cooked on the rod, being careful to secure it in the center with the special forks.
- **Important!**
Take care, the forks are sharp!
- Insert the rod into the motor opening (fig. 2.2a, 2.2b). It is correctly fitted only if the rod does not turn when inserted. It will then rotate only when the spit motor is operating (check the right rotation of the rod).
- Rest the rod onto the support of the spit collar (fig. 2.2a, 2.2b); then remove the grip by turning it to the left.
- Close the oven door and switch the knob in the position  .
The rotation direction of the rotisserie can be either clockwise or counter-clockwise.

Very important: The rotisserie must always be used with the oven door closed.

Do not grill for longer than 60 minutes at any one time.

Attention: The oven door becomes very hot during operation. Keep children away.

CAUTION: When the grill is on, some parts may become hot. Keep children away.

STERILIZATION

Sterilization of foods to be conserved, in full and hermetically sealed jars, is done in the following way:

- Set the switch to position .
- Set the thermostat knob to position 185°C and preheat the oven.
- Fill the grill pan with hot water.
- Set the jars into the grill pan making sure they do not touch each other and the door and set the thermostat knob to position 135°C.



When sterilization has begun, that is, when the contents of the jars start to bubble, turn off the oven and let cool.

REGENERATION

Set the switch to position  and the thermostat knob to position 150°C.

Bread becomes fragrant again if wet with a few drops of water and put into the oven for about 10 minutes.

COOKING DIFFERENT DISHES AT THE SAME TIME

With the function selector in position  or , the ventilated oven allows you to cook different types of food at the same time.

Fish, cakes and meat can be cooked together without the smells and flavours mixing.

The only precautions required are the following:

- The cooking temperatures must be as close as possible with a maximum difference of 20 - 25°C between the different foods.
- Different dishes must be placed in the oven at different times according to the cooking time required for each one. This type of cooking obviously provides a considerable saving on time and energy.

GRILLING AND “AU GRATIN”

Grilling may be done by selecting grill+fan setting  with the function selector knob, because the hot air completely envelops the food that is to be cooked.

Set the thermostat knob between the minimum and 200°C maximum, and after having preheated the oven, simply place the food on the grid.

Close the door and let the oven operate until grilling is done.

Adding a few dabs of butter before the end of the cooking time gives the golden “au gratin” effect.

Do not grill for longer than 60 minutes at any one time.

CAUTION: When the grill is on, some parts may become hot. Keep children away.

USE OF THE GRILL

Leave to warm up for approximately 5 minutes with the door **closed**.

Place the food inside positioning the rack as near as possible to the grill.

Insert the drip pan under the rack to collect the cooking juices.

Always grill with the oven door closed.

CAUTION: You can only use the grill function after an oven-cooking cycle if the temperature you set is higher than the one just used for oven cooking.

Do not grill for longer than 60 minutes at any one time.

CAUTION: When the grill is on, some parts may become hot. Keep children away.

OVEN COOKING

To cook, before introducing the food, preheat the oven to the desired temperature.

When the oven has reached the desired temperature, introduce the food, control the cooking time and turn off the oven 5 minutes before the theoretical time to recuperate the stored heat.

PIZZA STONE (SOME MODELS ONLY)

Pizza Stone, the baking stone that retains the moisture from the dough and distributes heat evenly, is made with materials that can reach and maintain high temperatures. Ideal accessory for cooking pizza, bread and focaccia.

PIZZA FUNCTION

1. Place the pizza stone on an oven grid. Insert the grid on the first level of the side rack, counting from the bottom.
2. Turn on and preheat the oven with the stone inside. Select the pizza function  and set the temperature to 300°C. Now preheat for at least 30 minutes. Do not preheat the oven with the turbo/booster function.
3. Once the oven has reached 300°C, place the pizza on the pizza stone.
4. For optimum cooking, see the Pizza Function table.
5. After cooking, leave the stone in the oven to cool completely.

CLEANING THE PIZZA STONE

Once the pizza stone has cooled down, clean it with a soft damp cloth, avoiding direct contact with water.

If necessary, use a metal spatula or knife to remove any food residues before cleaning with the cloth.

The stone is made of porous material, so do not wash it with detergents.

Do not wash in a dishwasher.

With use, dark patches may appear on the pizza stone: these have no effect on the quality of cooking.

LEAVENING FUNCTION (SOME MODELS ONLY)

The leavening function cuts the time it takes for your dough to rise.

Put the dough in an oven-proof container and place the container on an oven grid on the third level.

Turn the switch knob to the leavening function and set the thermostat to 40°C. See corresponding icons.

Leave the dough to rise in the oven until it reaches twice its original volume. Leavening times may vary according to dough type and room temperature.

DESSERT DISH (SOME MODELS ONLY)

Aluminium tray, ideal for cooking biscuits and pastries.

The tray has a flat, non-stick surface, so there is no need to grease it or use baking paper to get perfect bakes.

Do not wash in a dishwasher.

AIR FRY ENAMELLED TRAY (Some models only)

The special Air Fry enamelled tray has a perforated surface so as to facilitate the entry of air, giving the dishes a tasty crispy effect without adding condiments.

Recommended for:

French fries (frozen potatoes classic or rustics), chicken wings, potato croquettes and other frozen or pre-cooked foods.

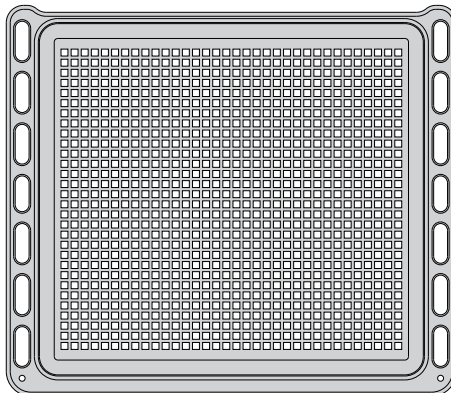
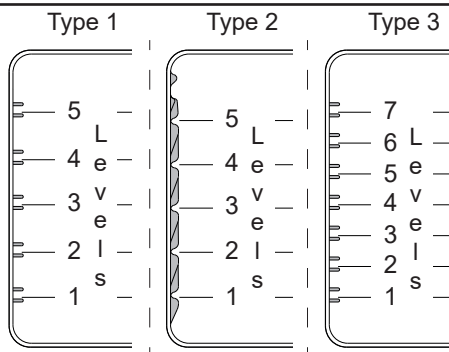

Fig. 2.3

COOKING ADVICE

The cooking settings specified in the tables below are guidelines and may vary according to the type and quantity of ingredients and the type of accessory used.

The appliance's cooking performance may differ from the performance of your previous appliance. You may therefore need to review the settings you usually use (temperature, cooking time and which level you place the oven grid on) according to the recommendations provided in the tables.









Remember to use ovenproof dishes and to adjust the oven temperature during cooking if necessary. For best results, always preheat the oven.

Not all of the accessories/ovenware are included in the standard equipment. Those that are not included can be ordered as optional accessories or purchased on the open market.



PIZZA

	WEIGHT [gr]	TEMP. [°C]	FUNCTION	LEVELS [1÷5]	LEVELS [1÷7]	TIME [min.]	WATER [ml]	ACCESSORIES / DISHES
MARGHERITA PIZZA	180	300	 or 	1 or 2-3	1 or 3-4	4 - 5		Pizza stone
CAPRICCIOSA PIZZA	180	300	 or 	1 or 2-3	1 or 3-4	5 - 6		Pizza stone
CALZONE PIZZA	180	300	 or 	1 or 2-3	1 or 3-4	5 - 7		Pizza stone



BAKERY

	WEIGHT [gr]	TEMP. [°C]	FUNCTION	LEVELS [1÷5]	LEVELS [1÷7]	TIME [min.]	WATER [ml]	ACCESSORIES / DISHES
BIGA BREAD	390-410	210-230		2	2	25-35	110-130	Pizza stone
BREAD 4 pieces	90-110 piece	225-240		2-3	3	30-40	100-170	Pizza stone
FOCACCIA WITH OLIVES	400-500	245-260		2-3	3	20-25		Aluminium baking tray
CLASSIC FOCACCIA	400-500	225-240		2-3	3	20-25		Aluminium baking tray



FIRST COURSES

	WEIGHT [gr]	TEMP. [°C]	FUNCTION	LEVELS [1÷5]	LEVELS [1÷7]	TIME [min.]	WATER [ml]	ACCESSORIES / DISHES
LASAGNE	900-1000	175-190		2-3	3	25-35		Aluminium baking tray
AUBERGINE PARMESAN	600-750	180-200		2-3	3	20-30		Aluminium baking tray
SAVOURY CAKE	800-900	190-210		2-3	3	40-50		Aluminium baking tray



VEGETABLES

	WEIGHT [gr]	TEMP. [°C]	FUNCTION	LEVELS [1÷5]	LEVELS [1÷7]	TIME [min.]	WATER [ml]	ACCESSORIES / DISHES
POTATOES	240-260	170-190		2-3	3	35-45		Baking tray
CARROTS	150-170	170-190		2-3	3	30-40		Baking tray
BROCCOLI	150-160	165-180		2-3	3	20-30	155-165	Baking tray
CAVOLFLOWERS	400-500	165-180		2-3	3	20-30		Baking tray



MEAT

	WEIGHT [gr]	TEMP. [°C]	FUNCTION	LEVELS [1+5]	LEVELS [1+7]	TIME [min.]	WATER [ml]	ACCESSORIES / DISHES
ROAST VEAL	350-450	160-180		2-3	3	80-100	150-170	Baking tray



FISH

	WEIGHT [gr]	TEMP. [°C]	FUNCTION	LEVELS [1+5]	LEVELS [1+7]	TIME [min.]	WATER [ml]	ACCESSORIES / DISHES
SEA BASS	900-1000	175-190		3	4	30-40		Baking tray
TROUT 2 Portions	1100-1300	175-190		3	4	20-30	195-210	Baking tray
SEA BREAM	500-650	175-190		2-3	3	25-35	100-125	Baking tray
BAKED SEA BREAM	450-550	175-180		2-3	3	25-35		Baking tray
SLICE OF SALMON	150-250	190-210		2-3	3	10 - 15	100-125	Baking tray



POULTRY

	WEIGHT [gr]	TEMP. [°C]	FUNCTION	LEVELS [1+5]	LEVELS [1+7]	TIME [min.]	WATER [ml]	ACCESSORIES / DISHES
TURKEY RUMP	400-450	170-190		2-3	3	40-50	90-110	Baking tray
CHICKEN	1100-1300	190-210		2	2	65-75		Baking tray
ROASTED CHICKEN	1200-1400	190-210				85-95		Baking tray







SWEETS

	WEIGHT [gr]	TEMP. [°C]	FUNCTION	LEVELS [1÷5]	LEVELS [1÷7]	TIME [min.]	WATER [ml]	ACCESSORIES / DISHES
SPUNGE CAKE	360-430	175-180		2-3	3	20-30		Round cake tin
JAM CROSTATA	700-800	175-185		2-3	3	20-30		Cake tin
PLUM CAKE	450-550	160-180		2	2	30-40		Rectangular cake tin
MUFFIN	350-450	160-180		2	2	20-35	140-160	Muffin cups
STRUDEL	650-750	175-185		2-3	3	25-35		Baking tray
POUND CAKE	680-730	175-185		2-3	3	35-45		Round cake tin
APPLE CAKE	1350-1500	175-185		2-3	3	35-45		Round cake tin
BISCUITS	135-150	175-185		2	2	12-18		Dessert dish
BISCUITS	270-300	175-185		Multilevel 2 and 4	Multilevel 2 and 4	12-18		Dessert dish



FROZEN FOODS

	WEIGHT [gr]	TEMP. [°C]	FUNCTION	LEVELS [1÷5]	LEVELS [1÷7]	TIME [min.]	WATER [ml]	ACCESSORIES / DISHES
FROZEN POTATOES Classic	580-620	195-205	 or AIR FRY	3	3	12 - 15		Air fry tray
FROZEN POTATOES Rustics	600-700	215-225	 or AIR FRY	3	3	12 - 15		Air fry tray
NUGGETS	220-270	175-185	 or AIR FRY	3	4	12 - 17		Air fry tray
POTATO CROQUETTES	700-800	215-225	 or AIR FRY	3	4	14 - 17		Air fry tray
BATTERED VEGETABLE	450-550	215-225	 or AIR FRY	3	3	12 - 15		Air fry tray

3

60' or 120' ALARM – 120' CUT-OFF TIMER

MODELS WITH 60 or 120 MINUTES ALARM (fig. 3.1, 3.2)

The minute counter is a timed acoustic warning device which can be set for a maximum of 60 or 120 minutes.

The knob must be rotated clockwise as far as the 60 or 120 minute position and then set to the required time by rotating it anticlockwise.

ATTENTION - MOST IMPORTANT:
This is only an alarm that **DOES NOT** switch off the oven or grill.
REMEMBER TO TURN OFF THE OVEN OR GRILL MANUALLY.

NOTES: The knob and symbols may vary. The symbols may be printed on the knob itself.

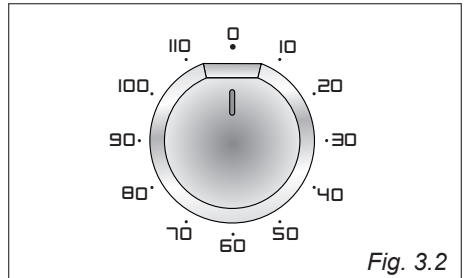
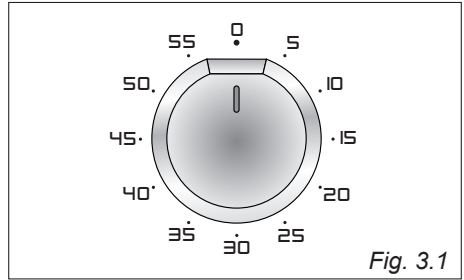

MODELS WITH 120 MINUTES CUT-OFF TIMER (fig. 3.3a, 3.3b)

The timer runs the oven for a preset time.

1. Starting up.

After setting the function selector and thermostat to the required mode and temperature, rotate the timer knob clockwise until you reach the required cooking time (max 120 minutes) (fig. 3.3a).

Once this time has elapsed, the timer will return to the "0" position and the oven will automatically switch off.

2. Manual position.

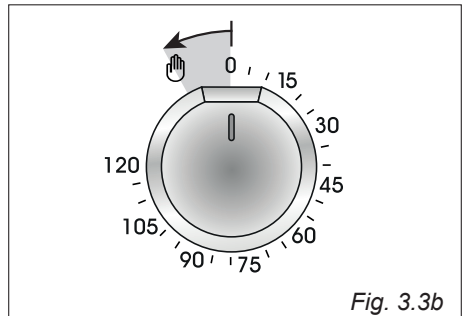
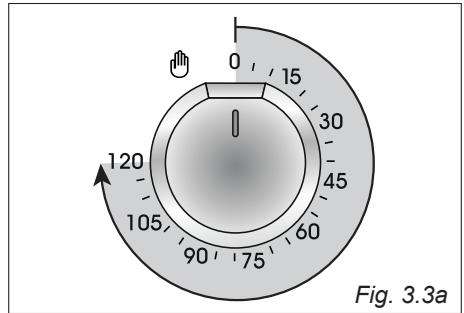

If the cooking time is longer than two hours or if you wish to use the oven manually, switching it off as required, the knob must be turned counterclockwise to position  (fig. 3.3b).









4 ELECTRONIC CLOCK / PROGRAMMER

The electronic clock/programmer is a device which groups together the following functions:

- 24 hours clock with illuminated display;
- timer (up to 23 hours and 59 minutes);
- program for automatic oven cooking;
- program for semi-automatic oven cooking.

Description of the illuminated symbols:	
AUTO flashing	Programmer in automatic or semi-automatic position but not programmed.
AUTO illuminated	Programmer in automatic or semi-automatic position with program inserted.
	Oven set for manual cooking or automatic/semi-automatic cooking taking place.
	Timer in operation.
 and AUTO flashing	Program error. (The time of day lies between the calculated cooking start and end time).

Note: Select a function by the respective button and, in 5 seconds, set the required time with the “E” / “F” buttons (“one-hand” operation). After a power cut the display resets to zero and cancels the set programs.

Description of the buttons:		
A	 or other equivalent symbols	Timer
B	 or other equivalent symbols	Cooking time
C	 or other equivalent symbols	End of cooking time
D	 or other equivalent symbols	Manual position, cancellation of the inserted cooking program and set the time of the day
E	 or other equivalent symbols	To decrease the numbers on the digital display
F	 or other equivalent symbols	To increase the numbers on the digital display

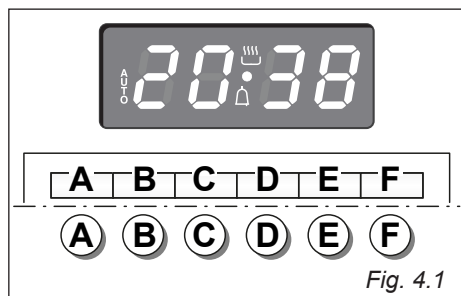

Fig. 4.1

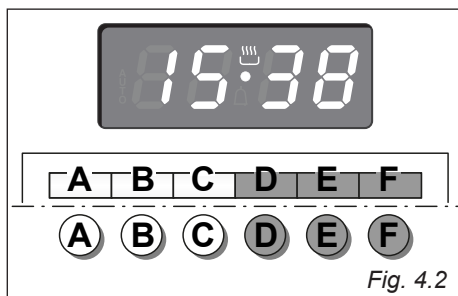

Fig. 4.2

ELECTRONIC CLOCK (fig. 4.2)

The programmer is equipped with an electronic clock with illuminated numbers which indicates hours and minutes.

Upon immediate connection of the oven or after a power cut, three zeros will flash on the programmer display.

To set the correct time of day it is necessary to push the “D” button and then the “E” or “F” button until you have set the correct time (fig. 4.2).

In another way push simultaneously the “B” / “C” two buttons and at the same time push the “E” or “F” button.

Note: If the clock is reset it deletes any previously set programs

NORMAL COOKING WITHOUT THE USE OF THE PROGRAMMER

To manually use the oven, without the aid of the programmer, it is necessary to cancel the flashing **AUTO** by pushing the “D” button (**AUTO** will be switched off and the symbol  will illuminate - fig. 4.3).

Attention: If the **AUTO** is illuminated (which means a cooking program has already been inserted), by pushing the button “D” you cancel the program and return to manual operation.

If the oven is switched on, you must switch it off manually.

ELECTRONIC TIMER

The timer program consists only of a buzzer which may be set for a maximum period of 23 hours and 59 minutes.

If the **AUTO** symbol is flashing push the “D” button.

To set the time, push the “A” button and the “E” or “F” until you obtain the desired time in the display (fig. 4.4).

Having finished the setting, the clock hour will appear on the panel and the  symbol will be illuminated.

The countdown will start immediately and may be seen at any moment on the panel by simply pressing the button “A”.

At the end of the time, the  symbol will disappear and the buzzer will sound for some minutes or until a button is pressed (not the “E” / “F” buttons).

After a short time the display will revert back to the time of day.

SETTING THE FREQUENCY OF THE AUDIBLE SIGNAL

The buzzer has 3 different tones and can be changed by pressing the “E” button, but only when the time of day is displayed

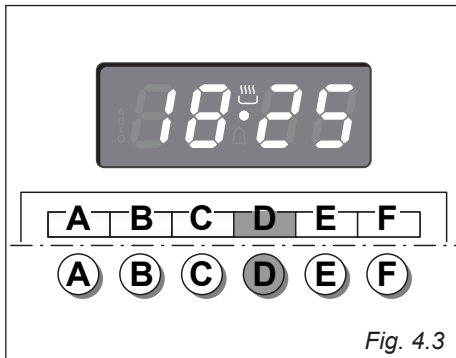

Fig. 4.3

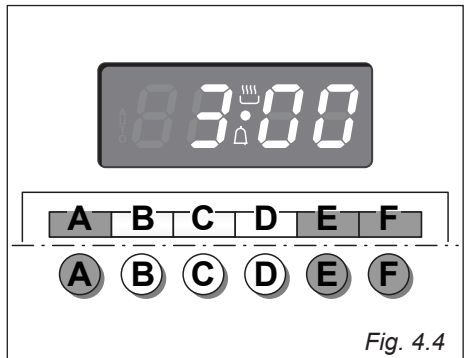



Fig. 4.4

AUTOMATIC OVEN COOKING

To cook food automatically in the oven, it is necessary to:

1. Set the length of the cooking period.
2. Set the end of the cooking time.
3. Set the temperature and the oven cooking program.

These operations are done in the following way:

1. Set the length of the cooking period by pushing the "B" button and the "F" button to increase or "E" to decrease if you have passed the desired time (fig. 4.5). The **AUTO** and the  symbol will illuminate.
2. Set the end of the cooking time by pressing the "C" button (the cooking time already added to the clock time will appear) and the "F" button (fig. 4.6); if you pass the desired time you may get back by pushing the "E" button.

After this setting, the  symbol will disappear. If after this setting, the **AUTO** flashes on the display and a buzzer sounds, it means there was an error in the programming, that is that the cooking cycle has been superimposed on the clock. In this case, modify the end of cooking time or the cooking period itself by following again the above mentioned instructions.

3. Set the temperature and the cooking function by using the switch and thermostat knobs of the oven (see specific chapters).

Now the oven is programmed and everything will work automatically, that is the oven will turn on at the right moment to end the cooking at the established hour.

During cooking, the  symbol remains illuminated.

By pushing the "B" button you can see the time that remains until the end of cooking.

The cooking program may be cancelled at any time by pushing "D".

At the end of the cooking time the oven will turn off automatically, the  symbol will turn off, **AUTO** will flash and a buzzer will sound, which can be turned off by pushing any of the buttons except the "E" / "F" buttons.

Turn the switch and thermostat knobs to zero and set the programmer onto "manual" by pressing the "D" button.

Attention: After a power cut the clock resets to zero and cancels the set programs.

After a power cut, three zeros will flash on the display.

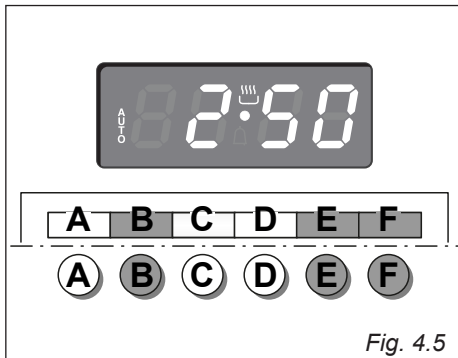

Fig. 4.5

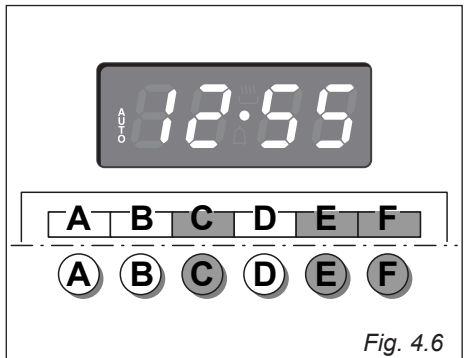

Fig. 4.6

SEMI-AUTOMATIC COOKING

This is used to automatically switch off the oven after the desired cooking time has elapsed.

There are two ways to set your oven:

1. Set the length of the cooking time by pushing the “B” button and the “F” button to advance, or “E” to go backwards if you have passed the desired time (fig. 4.7).
or
2. Set the end of the cooking time by pushing the “C” button and the “F” button to advance, or “E” to go backwards if you have passed the desired time (fig. 4.8).

AUTO and the  symbol will be on.

Then set the temperature and the cooking function using the oven switch and thermostat knobs (see specific chapters).

The oven is switched on and it will be switched off automatically at the end of the desired time.

During cooking, the  symbol remains on and by pressing the button “B” you can see the time that remains till the end of the cooking.

The cooking program may be cancelled at any time by pushing “D”.

At the end of the cooking time the oven will turn off automatically, the  symbol will turn off, **AUTO** will flash and a buzzer will sound, which can be turned off by pushing any of the buttons except the “E” / “F” buttons.

Turn the switch and thermostat knobs to zero and set the programmer onto “manual” by pressing the “D” button.

Attention: After a power cut the clock resets to zero and cancels the set programs.

After a power cut, three zeros will flash on the display.

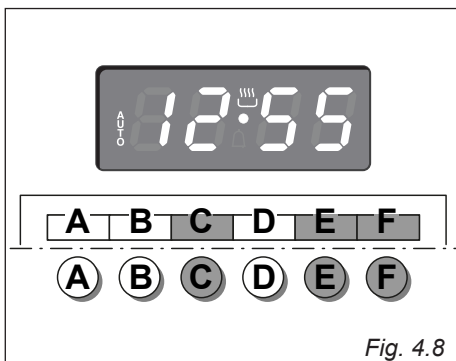
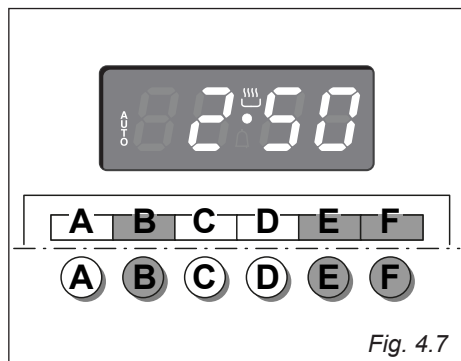

5

CLOCK AND TIMER WITH "TOUCH CONTROL" KEYS

Keys:		
A and C	⊕ and ⊖ or ⬆ and ⬇ or other equivalent symbols	Touched simultaneously (for more than 2 seconds): <ul style="list-style-type: none"> • setting the clock; • setting the timer volume (by touching once, along with the "B" key); • to cancel automatic cooking at any time.
B	MODE or other equivalent wording / symbol	Function selection (touched for more than 2 seconds): <ul style="list-style-type: none"> • setting the clock (only after first connection or after a power failure); • timer; • automatic cooking "dur" (duration) - how long the food will take to cook (by touching the "B" key again); • automatic cooking "End" - the time you would like the oven turns off (by touching the "B" key two more times).
A	⊖ or ⬇ or other equivalent symbols	Decreases the number shown on the display
C	⊕ or ⬆ or other equivalent symbols	Increases the number shown on the display

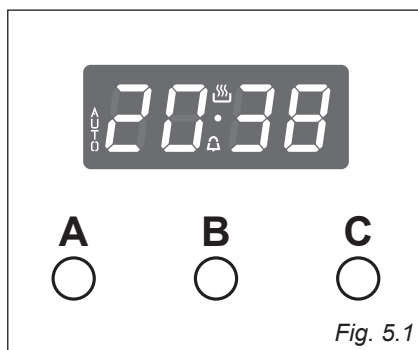

Fig. 5.1

Illuminated symbols:		
AUTO	flashing	Automatic cooking completed, oven in automatic position but not set
AUTO	steady illumination	Oven set for automatic cooking, cooking still not taking place
	flashing	Timer being set
	steady illumination	Timer in operation
	steady illumination	Oven set for manual cooking
and AUTO	AUTO flashing	Automatic cooking being set
and AUTO	steady illumination	Oven set for automatic cooking, cooking taking place

“TOUCH-CONTROL” KEYS

The “touch-control” keys shall be operated by the fingers (just by touching the key). When using touch controls it is best to use the ball of your finger rather than the tip.

The keys are automatically deactivated:

- 8 seconds after the last selection; the deactivation is indicated by an acoustic signal (“beep”).

To reactivate just touch the “B” key or the “A” and “C” keys (simultaneously) for more than 2 seconds.

SETTING THE CLOCK

When first connected, or after a power failure, the digits and “AUTO” will shown on the display.

Important: The oven does not operate, in manual cooking, without first having set the clock.

To set the clock, touch the “B” key, for more than 2 seconds, and then the “A” or “C” keys. To set the clock, with the appliance already connected, touch the “A” and “C” keys simultaneously (for more than 2 seconds), then “A” or “C” keys.

Important:



- changing the time will delete any automatic program;
- after setting the clock, the oven starts to operate in the selected function (manual cooking). The “” symbol is steady illuminated.

USING THE TIMER

You can use the timer at any time, even when the oven is not in use.

The timer does not turn the oven off.

The timer can be set for up to 23 hours and 59 minutes.

- To set the timer, touch the “B” key for more than 2 seconds (the “” symbol flashes), than the “C” or “A” keys.
- After about 8 seconds an acoustic signal (“beep”) will sound confirming the regulation (“” symbol steady illuminated).
- To check the remaining time touch the “B” key for more than 2 seconds. If the remaining time is more than a minute the display will show hours and minutes; if less than a minute the display will show seconds.
- When the time is up, the timer will beep. Touch the “B” key, for more than 2 seconds, to turn it off; or press the “A” or “C” key to stop the beep and than the “B” key, for more than 2 seconds, to deactivate the “” symbol flashing on the display.
- Turn off the oven manually (function and thermostat knobs in the off position) if the manual cooking has been completed.

SETTING THE TIMER VOLUME

You can select from three volume levels.

- Touch the “**A**” and “**C**” keys simultaneously for more than 2 seconds.
- Touch the “**B**” key; you can read on the display the current timer volume (“**ton1**”, “**ton2**” or “**ton3**”).
- Touch the “**A**” key to listen or change the timer volume.
- Timer volume activated: the last displayed.
- After about 8 seconds an acoustic signal (“**beep**”) will sound confirming the volume setting; then the time of day will be displayed.

AUTOMATIC COOKING

Use automatic cooking to automatically turn the oven on, cook, and then turn the oven off.

1. Check the clock shows the correct time.
2. Select the function and temperature (function and temperature knobs). The oven will come on.
3. Decide how long the food will take to cook, allowing time for preheating if necessary.
4. Touch the “**B**” key for more than 2 seconds and then touch again; “**dur**” will show (duration). Using the “**C**” and “**A**” keys, set the cooking time.
5. Decide the time you would like the oven to turn off; touch the “**B**” key for more than 2 seconds and then touch it two times again; “**End**” will show. Using the “**C**” and “**A**” keys, set the stop time.

Note: while “**dur**” is displayed you can change to “**End**” just by touching one time the “**B**” key (within 8 seconds from the last selection).

If there is time to wait before cooking starts, the current time of day and “**AUTO**” will show in the clock display. The oven will switch off but is now set for automatic cooking.

If you are already at home to turn the oven on and only want the oven to turn off automatically, start cooking as normal, then follow step 4 or step 5 to set a time to stop the oven.

When automatic cooking starts, “” will be displayed and the oven will turn on.

- To see the remaining cook time, follow step 4 up to display “**dur**” (duration).
- To see the set stop time, follow step 5 up to display “**End**”.
- To cancel automatic cooking at any time, touch the “**A**” and “**C**” keys simultaneously (for more than 2 seconds) and turn the temperature and function knobs to the off position.

When the stop time is reached, the oven will turn off, the timer will beep and “**AUTO**” will flash:

- Touch any key to stop the beeping.
- Touch the “**B**” key, for more than 2 seconds, to return the oven to the manual mode (“” symbol steady illuminated on the display).
- Turn the temperature and function knobs to the off position.

Attention: After a power failure any automatic program is deleted. Turn off the oven manually.

6

ELECTRIC CLOCK/PROGRAMMER

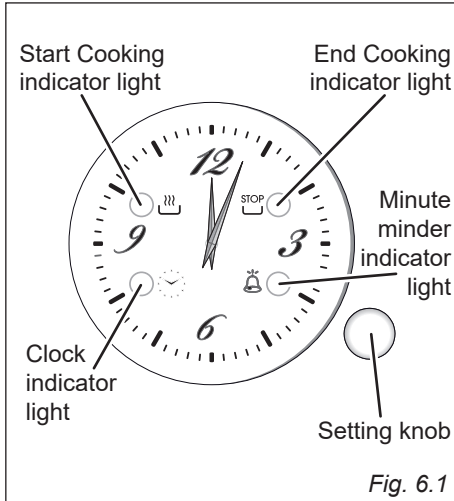

Fig. 6.1

The electric clock/programmer is a device which groups the following functions:

- 12-hour analog clock;
- minute minder (max 3 hours);
- automatic cooking (* see note below);
- acoustic signal (beep) which is activated each time the “setting knob” is pressed or at the end of the minute minder function or automatic cooking program.

(*) The maximum programmable time (MPT) depends from the set start cooking time.

MPT = 15 hours - difference of hours between the set start cooking time and the time of day (eg. time of day = 08:00, set start cooking time = 11:00; MPT = 15 - 3 = 12 hours).

ELECTRIC CLOCK

Upon immediate connection of the appliance or after a blackout, the “clock indicator light” is flashing. This indicates that it is recommended to check if the time of the day is correct.

- If the time of the day is correct keep the “setting knob” pressed until the “clock indicator light” goes out.
- To set the time of the day press the “setting knob” briefly (repeatedly) until the “clock indicator light” is flashing. Then turn the “setting knob” (to the right or left) to set the time of the day. At the end of the time adjustment, keep the “setting knob” pressed for confirmation until the “clock indicator light” goes out.

MINUTE MINDER

The minute minder function consists only of a buzzer which is automatically activated at the end of the set time (max 3 hours).

Important: It is not possible to use the minute minder function if an automatic cooking has been set.

To set the minute minder press the “setting knob” briefly (one or more times) until the “minute minder indicator light” is flashing.

Then turn the “setting knob” (to the right or left) to set the time.

At the end of the adjustment (within 10 seconds), keep the “setting knob” pressed for confirmation until the “minute minder indicator light” changes from flashing to steadily lit.

Then the countdown starts immediately.

At the end of the time, the “minute minder indicator light” changes from steadily lit to flashing and a buzzer (beep) sounds for one minute.

Press the “setting knob” briefly to stop the buzzer and to turn off the flashing “minute minder indicator light”.

During the minute minder program it is possible, at any time, to display the set time by pressing the “setting knob” briefly (one or more times) until the “minute minder indicator light” is flashing.

To cancel the program before completion, keep the “setting knob” pressed for about 3 seconds until the “minute minder indicator light” goes out; the minute minder function will be cancelled.

**ATTENTION - MOST IMPORTANT:
This is only an alarm that DOES NOT
switch off the oven or grill.
REMEMBER TO TURN OFF THE
OVEN OR GRILL MANUALLY.**

AUTOMATIC COOKING

Use automatic cooking to automatically turn the oven on, cook, and then turn the oven off.

1. Check the clock shows the correct time.
2. Select the function and temperature (function and temperature knobs). The oven will come on.
3. Press the “setting knob” briefly (one or more times) until the “Start Cooking indicator light” is flashing.

Then turn the “setting knob” (to the right or left) to set the start cooking time (not less than 2 minutes and max 12 hours from the current time of the day).

At the end of the adjustment (within 10 seconds), keep the “setting knob” pressed for confirmation until the “Start Cooking indicator light” changes from flashing to steadily lit.

4. Decide how long the food will take to cook, allowing time for preheating if necessary.
Press the “setting knob” briefly (one or more times) until the “End Cooking indicator light” is flashing.

Then turn the “setting knob” (to the right or left) to set the end cooking time (at least 2 minutes from the set start cooking time).

At the end of the adjustment (within 10 seconds), keep the “setting knob” pressed for confirmation until the “End Cooking indicator light” changes from flashing to steadily lit.

If there is time to wait before cooking starts, the oven will switch off but is now set for automatic cooking.

If you are already at home to turn the oven on and only want the oven to turn off automatically, start cooking as normal, then follow step 4 to set a time to stop the oven.

- To see the set start cooking time, press the “setting knob” briefly (one or more times) until the “Start Cooking indicator light” is flashing.
- To see the set stop time, press the “setting knob” briefly (one or more times) until the “End Cooking indicator light” is flashing.
- To cancel the program before completion, keep the “setting knob” pressed for about 3 seconds until the “Start Cooking indicator light” and/or “End Cooking indicator light” go/goes out. **REMEMBER TO TURN OFF THE OVEN OR GRILL MANUALLY.**

When the stop time is reached, the oven will turn off, the “End Cooking indicator light” changes from steadily lit to flashing and a buzzer (beep) sounds for one minute.

- Press the “setting knob” briefly to stop the buzzer and to turn off the flashing “End Cooking indicator light”.
- Turn the temperature and function knobs to the off position.

Attention: After a power failure any automatic program is NOT deleted and the “clock indicator light” is flashing (this indicates that it is recommended to check if the time of the day is correct).

7

ELECTRONIC CLOCK/PROGRAMMER "TOUCH-CONTROLS"

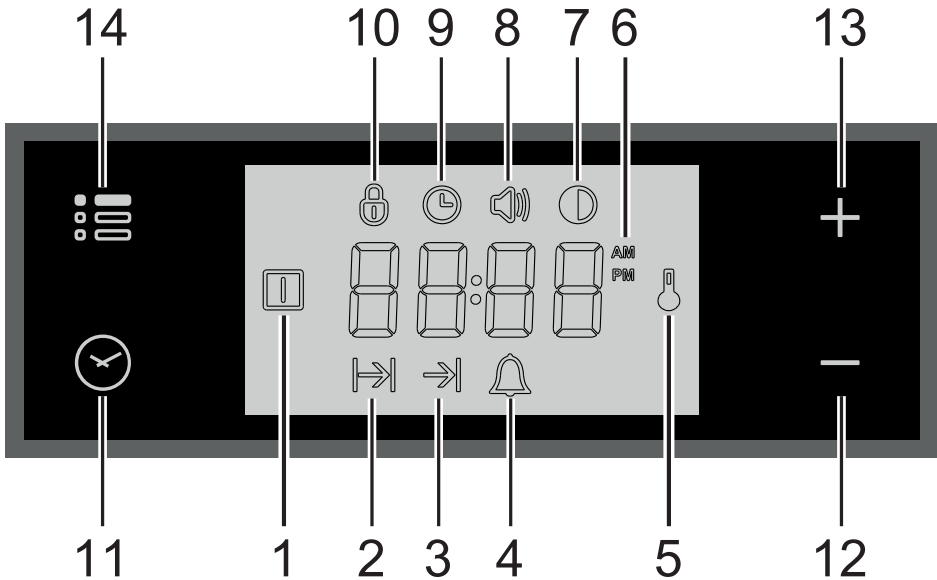

Description of display symbols:

1. Oven on
2. Cooking time
3. End of cooking time
4. Timer
5. Oven temperature
6. AM/PM time format
7. Screen brightness
8. Acoustic signal volume
9. Time of day setting
10. Programmer 'touch' control panel key lock

Description of the 'touch control' panel symbols:

11. Program selection
12. Digit backward setting for all functions
13. Digit forward setting for all functions
14. Menu selection

IMPORTANT NOTE: When using the timer and during a semi-automatic or automatic cooking, the countdown of the function with less time remaining prevails on the display.

ATTENTION - MOST IMPORTANT:

ELECTRONIC PROGRAMMER DISPLAY CLEANING

Strictly follow the information indicated in the chapter "CLEANING AND MAINTENANCE".

“TOUCH-CONTROL” KEYS

The “touch-control” keys shall be operated by the fingers (just by touching the key).

When using touch controls it is best to use the ball of your finger rather than the tip.

Program and menu selection: after starting the procedure, the selection is automatically deactivated after approx. 5 seconds from the last touch on the display.

SETTING THE CLOCK

When connecting for the first time, or after a power failure, the word “OFF” flashes on the display and the “🕒” symbol is lit. Adjust the time touching the “+” or “-” key.

Important: The oven does not operate, in manual cooking, without first having set the clock.

To change the time with the appliance already installed, touch the “🕒” key for more than 2 seconds, then touch it again until the “🕒” symbol flashes. Then adjust the time, within 5 seconds, using the “+” or “-”.

Important: It is not possible to adjust the clock if a cooking program is in progress.

USING THE TIMER

You can use the timer at any time, even when the oven is not in use.

ATTENTION - MOST IMPORTANT: This is only an alarm that DOES NOT switch off the oven or grill.

REMEMBER TO TURN OFF THE OVEN/GRILL MANUALLY.

The timer can be set for a maximum time of 23 hours and 59 minutes.

1. To set the timer, with the appliance already connected, touch the “🕒” key (several times) until the “🔔” symbol flashes on the display. Set the time (increase in minutes) within 5 seconds using the “+” or “-” key. At the end of the adjustment the display shows the countdown.
2. At the end of the count, the timer starts beeping and the “🔔” symbol flashes on the display. Touch any key to turn off the acoustic signal that would otherwise stop after 7 minutes.
3. Turn the oven off manually (switch and thermostat knobs in the off position) if you do not wish to continue with manual cooking.

To reset the timer in operation at any time:

- 1A. Only timer function active (no semi-automatic or automatic cooking in progress): touch the “🕒” key for 3 seconds..
- 1B. With semi-automatic or automatic cooking in progress: touch the key several times “🕒” until the “🔔” symbol flashes on the display. Then touch the “-” key within 5 seconds until “00:00” appears on the display.
2. The time of day is shown on the display.

SEMI-AUTOMATIC COOKING

This is used to automatically switch off the oven after the desired cooking time has elapsed. Check the clock shows the correct time.

The semi-automatic cooking program can be set for a maximum period of 10 hours.

1. Select the function and temperature (function and temperature knobs). The oven will come on.
2. Touch the "⏸" key until the "⏸" symbol flashes on the display. Set the cooking time (increase in minutes - consider the preheating time, if necessary) within 5 seconds using the "+" or "-". At the end of the adjustment the display shows the countdown.
3. At the end of the count the oven turns off, the timer starts beeping, the "⏸" symbol flashes and the word "End" appears on the display.
4. Turn the temperature and function knobs to the off position.
5. Touch the "⏸" key to deactivate the acoustic signal (which otherwise will stop after 7 minutes) and to return the programmer to manual mode (the time is shown on the display). If instead the acoustic signal is deactivated with one of the other keys, after deactivation also touch the "⏸" key to return the programmer to manual mode (the time is shown on the display).

To cancel the semi-automatic cooking program at any time:

- 1A. Only semi-automatic cooking function active (no timer in use): touch the "⏸" key for 3 seconds, the "⏸" symbol and the word "End" are shown on the display.
- 1B. With active timer: touch the "⏸" key several times until the "⏸" symbol flashes. Then touch the "-" key within 5 seconds until "00:00" appears on the display, replaced after a few seconds by the "⏸" symbol and the word "End".
2. Touch the "⏸" key again to return the programmer to manual mode (the time of day is shown on the display). If cooking is finished turn the temperature and function knobs to the off position, otherwise continue cooking and then remember to turn the oven off manually.

AUTOMATIC COOKING

Use automatic cooking to automatically turn the oven on, cook, and then turn the oven off. Check the clock shows the correct time.

1. Select the function and temperature (function and temperature knobs). The oven will come on.
2. Decide the cooking time considering the preheating time, if necessary, and set it as described above in the "SEMI-AUTOMATIC COOKING" chapter.
3. Touch the "⏸" key several times until the "⏸" symbol appears on the display. Then set the time at which you want the oven to turn off, touching the "+" or "-" key.
4. If the cooking is not started immediately, the display shows the current time of day and the "⏸" and "⏸" symbols. The oven turns off but now it is set for automatic operation.
 - To check the cooking time, touch the "⏸" key once, the "⏸" symbol flashes.
 - To check the turn-off time, touch the key "⏸" several times until the "⏸" symbol flashes.

To cancel the automatic cooking program at any time, proceed as described in the "SEMI-AUTOMATIC COOKING" chapter.

Turn the temperature and function knobs to the off position, otherwise continue cooking and then remember to turn the oven off manually.

ATTENTION - VERY IMPORTANT (AUTOMATIC OR SEMI-AUTOMATIC COOKING):

If a very short power interruption occurs, the oven keeps the programming.

If the interruption is instead longer than a few tens of seconds, the automatic cooking is cancelled. In this case, turn the temperature and function knobs to the off position and restart programming if necessary.



USER PREFERENCES SETTINGS

PROGRAMMER 'TOUCH CONTROL' PANEL KEY LOCK



This function is used to prevent the accidental touch of the programmer selection keys and to avoid unintentionally activating or modifying its functions.

The key lock can be activated at any time, with a cooking in progress or with the oven off.

To lock:



- Touch the "" key for more than 2 seconds until the "" indicator light starts flashing. Then touch the "+" key to activate the key lock, the word "On", appears on the display, wait a few seconds until the operation is completed. When this function is active, the "" indicator light is on.

To unlock:

- Touch the "" key for more than 2 seconds until the "" indicator light starts flashing. Then touch the "-" key to deactivate the key lock, the word "OFF" appears on the display, wait a few seconds until the operation is completed. When this function is not active, the "" indicator light is off.

ACOUSTIC SIGNAL TONE SETTING

It is possible to select three sound tones.

- Touch the "" key for more than 2 seconds, then touch the same key several times until the "" symbol flashes.
- Touch the "+" or "-" key; the display shows the tone set ("b-01", "b-02" or "b-03").
- The last tone displayed remains active.

SCREEN BRIGHTNESS SETTING

It is possible to select three brightness levels.

- Touch the "☰" key for more than 2 seconds, then touch the same key several times until the "Ⓢ" symbol flashes.
- Touch the "+" or "-"; key; the display shows the brightness set ("d-01", "d-02" or "d-03").
- The last brightness displayed remains active.

TIME FORMAT

It is possible to choose the 24 hour or 12 hour clock format.

- To activate the 12 hour format, touch the "+", key for more than 5 seconds until the "AM" or "PM" symbol is activated.
- To activate the 24 hour format, touch the "+", key for more than 5 seconds until the "AM" or "PM" symbol is deactivated.

8

CLEANING AND MAINTENANCE

GENERAL ADVICE

- **Important: Before any operation of cleaning and maintenance disconnect the appliance from the electrical supply.**
- It is advisable to clean when the appliance is cold and especially when cleaning the enamelled parts.
- Avoid leaving alkaline or acidic substances (lemon juice, vinegar, etc.) on the surfaces.
- Avoid using cleaning products with a chlorine or acidic base.
- Always clean the oven with appropriate products after use.
- **Important: The use of suitable protective clothing/gloves is recommended when handling or cleaning of this appliance.**

WARNING:

When correctly installed, your product meets all safety requirements laid down for this type of product category. However special care should be taken around the rear or the underneath of the appliance as these areas are not designed or intended to be touched and may contain sharp or rough edges, that may cause injury.

ENAMELLED PARTS

All the enamelled parts must be cleaned with a sponge and soapy water or other non-abrasive products.

Dry preferably with a microfibre or soft cloth.

Acidic substances like lemon juice, tomato sauce, vinegar etc. can damage the enamel if left too long.

STAINLESS STEEL, ALUMINIUM PARTS AND PAINTED OR SILK-SCREEN PRINTED SURFACES

Clean using an appropriate product. Always dry thoroughly.

IMPORTANT: These parts must be cleaned very carefully to avoid scratching and abrasion. You are advised to use a soft cloth and neutral soap.

CAUTION: Do not use abrasive substances or non-neutral detergents as these will irreparably damage the surface.

Important: The manufacturer declines all liability for possible damage caused by the use of unsuitable products to clean the appliance.

The appliance gets very hot, mainly around the cooking areas. It is very important that children are not left alone in the kitchen when you are cooking.

Do not store flammable material in the oven.

Do not use a steam cleaner because the moisture can get into the appliance thus make it unsafe.

Do not use harsh abrasive cleaners or sharp metal scrapers to clean the oven door glass since they can scratch the surface, which may result in shattering of the glass.

GLASS CONTROL PANEL (some models only)

Clean using an appropriate product. Always dry thoroughly.

Do not use harsh abrasive cleaners or sharp metal scrapers to clean the control panel since they can scratch the surface, which may result in shattering of the glass.

ELECTRONIC PROGRAMMER DISPLAY CLEANING (SOME MODELS ONLY)

Clean the programmer display using a soft cloth, warm water and neutral soap, or a soft cloth with a liquid detergent (non-abrasive).

When cleaning, be careful to move the cloth in one direction only.

Then wipe the display with a damp cloth and dry it with a soft cloth.

IMPORTANT: DO NOT use chlorine-based or acid-based cleaning products, abrasive products or non-neutral detergents as they may cause irreparable damage to the surface. DO NOT spray cleaning liquids directly on the programmer display.

INSIDE OF OVEN

The oven should always be cleaned after use when it has cooled down.

The cavity should be cleaned using a mild detergent solution and warm water.

Suitable proprietary chemical cleaners may be used after first consulting with the manufacturers recommendations and testing a small sample of the oven cavity.

Abrasive cleaning agents, scouring pads/cloths or sharp metal scrapers should not be used on the cavity surface.

NOTE: The manufacturers of this appliance will accept no responsibility for damage caused by chemical or abrasive cleaning.

Let the oven cool down and pay special attention no to touch the hot heating elements inside the oven cavity.

CLEANING THE CIRCULAR WELL ON THE FLOOR OF THE OVEN

After using the Easy Steam and Idroclean functions, you are advised to clean and dry the circular well on the floor of the oven.

All enamelled parts must be cleaned using a sponge and soapy water or other suitable non-abrasive products.

Dry with a soft cloth.

IDROCLEAN (on certain models only)

1. **With the oven cold, remove all accessories**, pour 100 ml of drinking water into the circular well on the floor of the oven and switch on the Idroclean function  at 80-90°C. Do not use any type of detergent.
2. Run the function for at least 35 minutes, depending on the type of dirt: the moisture generated inside the oven will help remove the dirt.
3. **Once the oven is completely cold**, wipe the inside of the oven with a damp cloth to remove any residues, and use a soft cloth to wipe any condensation off the inside of the oven or the inside of the door glass.

The Idroclean function provides quick, everyday, detergent-free cleaning, but **is not a substitute for the more thorough cleaning** needed to remove baked-on dirt: for this purpose, clean by hand, using specific products. For best results, the Idroclean function should be used after each cooking cycle.

CAUTION: never open the oven door or top up the water in the well on the floor of the oven when the Idroclean function is in operation.

Burns hazard!

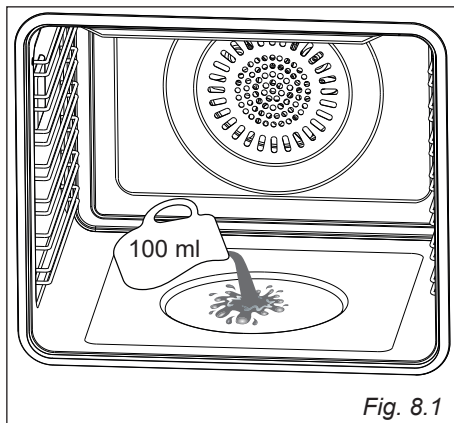

Fig. 8.1

OVEN FITTING OUT

1. MODELS WITH SIDE WIRE RACKS:

Assembly of the side runner frames

- Slide the rear prongs of the side rack into the holes "A" at the rear of the oven (fig. 8.2a).
- Slide the front prong of the side rack into the holes at the front of the oven (fig. 8.2b).
- Slide in, on the guides, the shelf and the tray (fig. 8.2c).

The shelf must be fitted so that the safety notch, which stops it sliding out, faces the inside of the oven; the guard rail shall be at the back.

- To dismantle, operate in reverse order.

Fit the catalytic panel to the side rack (some models only)

- Make sure the panels are fitted correctly (with the arrow pointing up and the rear holes aligned with holes "A" in the back of the oven): the cut-out in the panel must be placed over the light in the oven (certain models only).
- The panels must be positioned between the inside wall of the oven and the side rack. Once the catalytic panels are in place, securing the side rack will also secure the panels.

2. MODELS WITH EMBOSSED CAVITY:

- The oven shelf is provided with a security block to prevent accidental extraction. It must be inserted operating as per figure 8.2d.
- To remove it, operate in the reverse order.

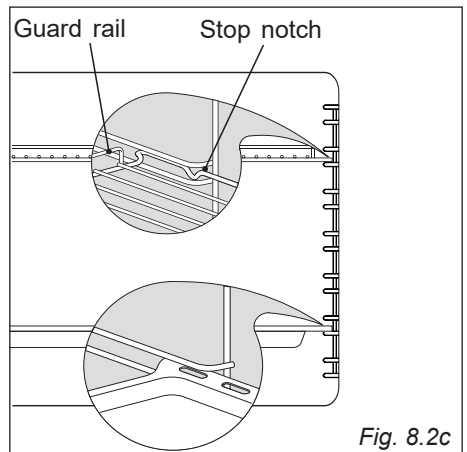
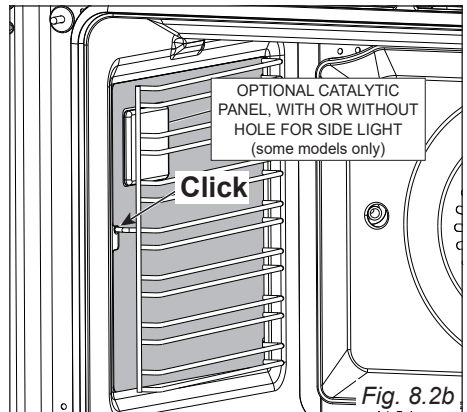
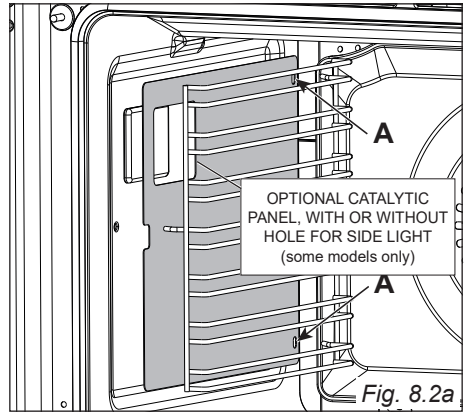

ADVICE FOR USE AND MAINTENANCE OF CATALYTIC PANELS (some models only)

The catalytic panels are covered with special microporous enamel which absorbs and does away with oil and fat splashes during normal baking over 200°C.

If, after cooking very fatty foods, the panels remain dirty, operate the oven "idling" on max temperature for about 30 minutes.

These panels do not require to be cleaned, however it is advised to periodically remove them from the oven and to wash them with tepid soapy water and then wipe off with a soft cloth.

Do not clean or wash them with abrasive products or with products containing acids or alkalis.

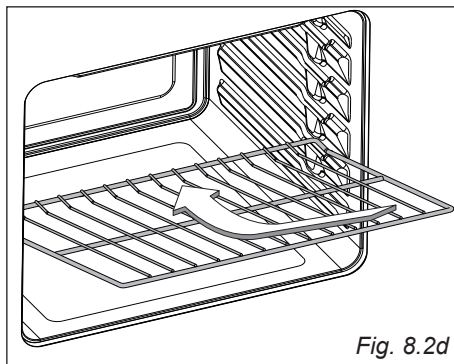

Fig. 8.2d

GREASE FILTER (some models only)

- A special screen is provided at the back of the oven to catch grease particles, mainly when meat is being roasted. Slide in the grease filters on the back of the oven as in fig. 8.3.
- When baking pastry etc. this filter should be removed.
- **Clean the filter after any cooking!**
The grease filter can be removed for cleaning and should be washed regularly in hot soapy water. Always clean the filters after cooking as any solid residues on it might adversely affect the oven performance.
- Always dry the filter properly before fitting it back into the oven.

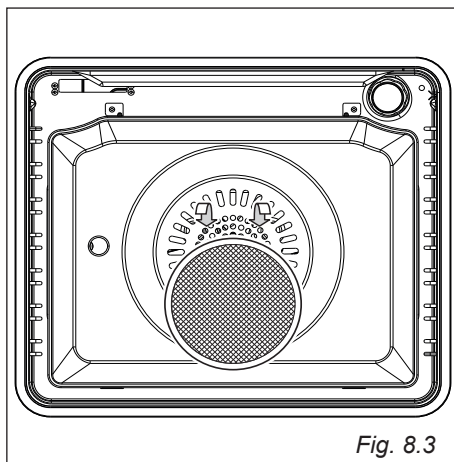

Fig. 8.3

TELESCOPIC SLIDING SHELF SUPPORTS (some models only)

The telescopic sliding shelf supports make it safer and easier to insert and remove the oven shelf and tray.

They stop when they are pulled out to the maximum position.

Important! When fitting the sliding shelf supports, make sure that you fit:

- The slides to the top wire of a rack. They do not fit on the lower wire.
- The slides so that they run out towards the oven door.
- Both sides of each pair of shelf slides.
- Both sides on the same level.

To fix the sliding shelf supports onto the side racks:

- Fit the sliding shelf supports onto the top wire of a rack and press. You will hear a click as the safety locks clip over the wire.

IMPORTANT NOTE: When cooking with the rotisserie DO NOT position the grill tray on the sliding shelf supports.

To remove the telescopic sliding supports, operate in reverse order.

Cleaning the sliding shelf supports:

- Wipe the supports with a damp cloth and a mild detergent only.
- Do not wash them in the dishwasher, immerse in soapy water, or use oven cleaner on them.

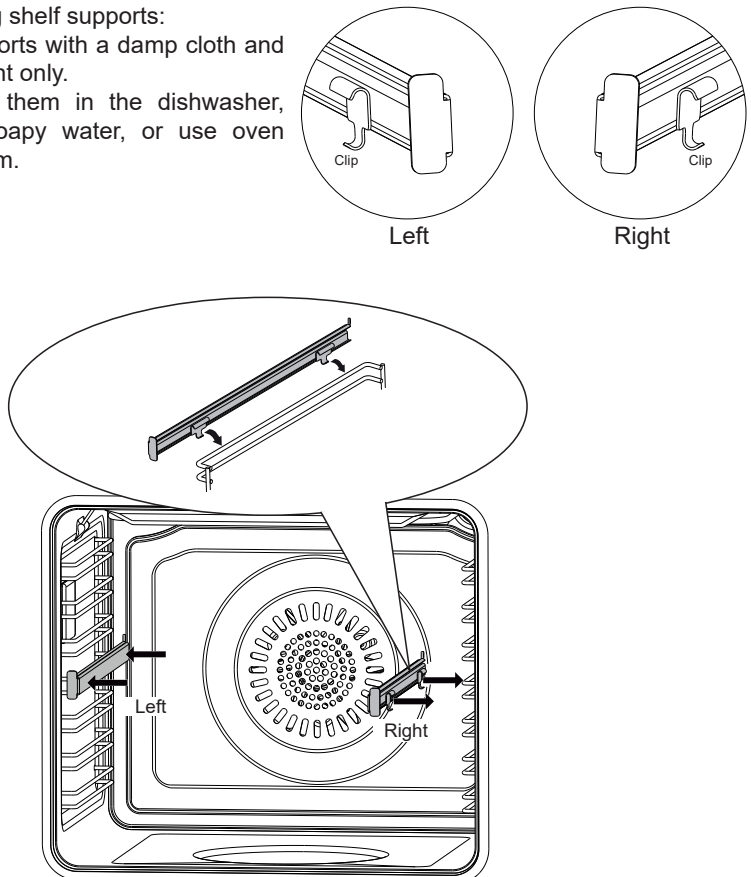

Fig. 8.4

REPLACING THE OVEN LIGHTS

(NOTE: DEPENDING ON YOUR MODEL, YOUR OVEN MAY ONLY HAVE SOME OF THESE LIGHTS)

WARNING: Ensure the appliance is switched off before replacing the lamp to avoid the possibility of electric shock.

- Let the oven cavity and the heating elements to cool down.
- Switch off the electrical supply.
- Remove the protective cover (fig. 8.5 - 8.6).
- Replace the halogen lamp with a new one suitable for high temperatures having the following specifications: 220-240 V ac and same power (check watt power as stamped in the bulb itself) of the replaced lamp.

IMPORTANT WARNING: Never replace the lamp with bare hands; contamination from your fingers can cause premature failure. Always use a clean cloth or gloves.

- Refit the protective cover.

NOTE: Oven bulb replacement is not covered by your guarantee.

The intended purpose of the lamp, fitted on this appliance, is to illuminate the oven cavity and thus help the user to better monitor the food while cooking. This lamp is not suitable for other usage (e.g. environments lighting).

This product contains a light source of energy efficiency class G.

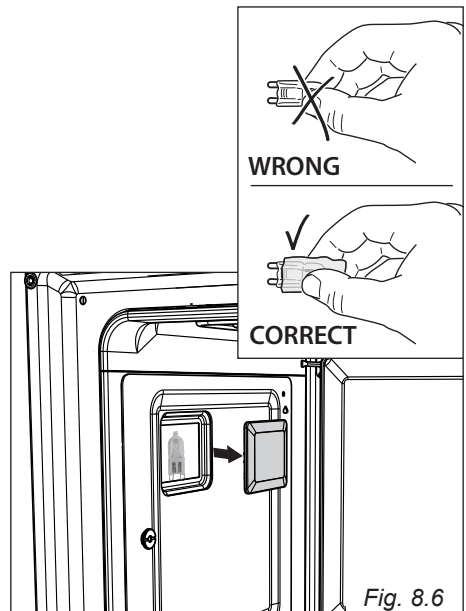
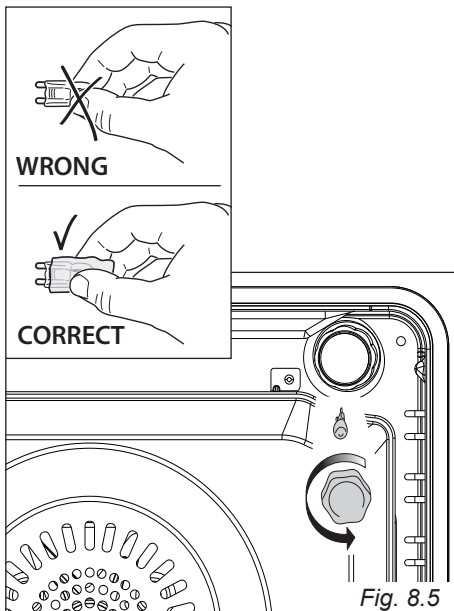

REMOVING AND REPLACING THE INNER AND MIDDLE DOOR GLASS PANES FOR CLEANING

If you wish to clean the inner pane of glass of the door, make sure you follow the precautions and instructions very carefully.

Replacing the glass pane and the door incorrectly may result in damage to the appliance and may void your warranty.

IMPORTANT!

- Take care, the oven door is heavy. If you have any doubts, do not attempt to remove the door.
- Make sure the oven and all its parts have cooled down. Do not attempt to handle the parts of a hot oven.
- Take extreme care when handling the glass pane. Avoid the edges of the glass bumping against any surface. This may result in the glass shattering.
- **CAUTION:**
Do not use harsh abrasive cleaners or sharp metal scrapers to clean the oven door panes of glass since they can scratch the surface, which may result in shattering of the glass.
- If you notice any sign of damage on any of the glass panes (such as chipping, or cracks), do not use the oven. Call your Authorised Service Centre or Customer Care.
- Make sure you replace the glass pane correctly. Do not use the oven without glass pane correctly in place.
- If the glass pane feels difficult to remove or replace, do not force it. Call your Authorised Repairer or Customer Care for help.
Note: service visits providing assistance with using or maintaining the oven are not covered by your warranty.

REMOVING THE OVEN DOOR

The oven door can easily be removed as follows:

- Open the door to the full extent (fig. 8.8).
- Open the lever "A" completely on the left and right hinges (fig. 8.9).
- Hold the door as shown in fig. 8.7.
- Gently close the door until left and right hinge levers "A" are hooked to part "B" of the door (fig. 8.9).
- Withdraw the hinge hooks from their location following arrow "C" (fig. 8.11).
- Rest the door on a soft surface.
- To replace the door, repeat the above steps in reverse order.

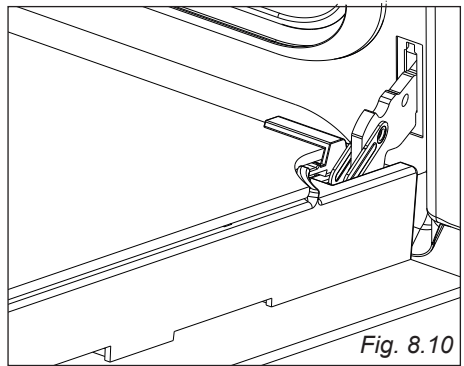
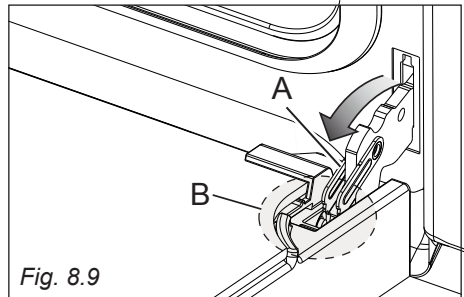
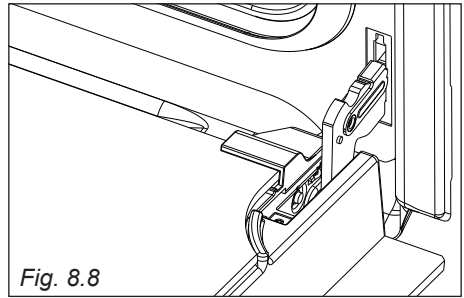

Important!

Always keep a safe distance from the door hinges, paying special attention to the position of your hands.

If the door hinges are not correctly hooked, they could unhook and close suddenly and unexpectedly with risk of injury.

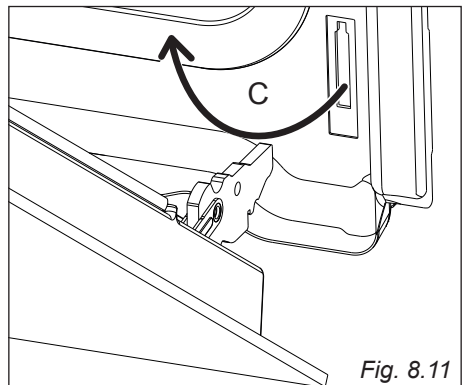
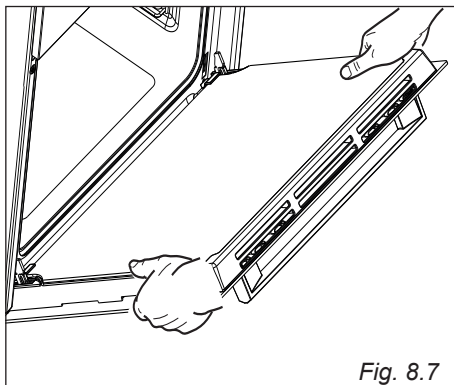
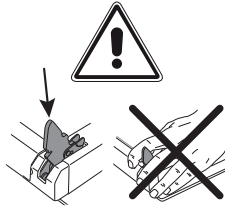

To remove the inner pane

- Touch the glass retainer tabs in on both sides of the door and remove the glass retainer (figs. 8.12, 8.13).
- Gently lift and pull out the inner pane of glass by releasing it from the bottom retainers. Do not angle the pane too much as you may damage the glass (fig. 8.14).

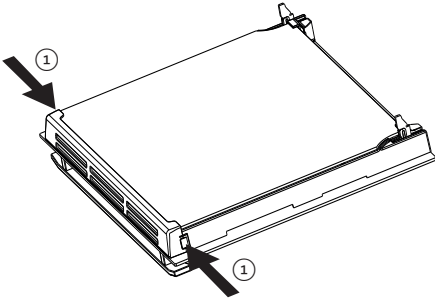

Fig. 8.12

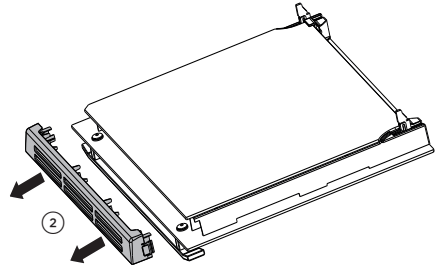

Fig. 8.13

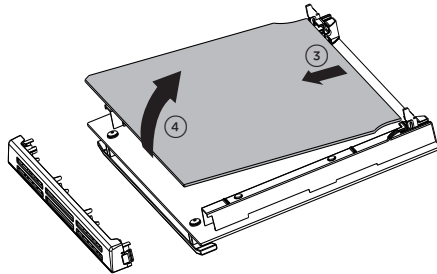

Fig. 8.14

To remove the middle pane (some models only)

- Gently lift and pull out the middle pane of glass by releasing it from the bottom retaining notches (fig. 8.15).

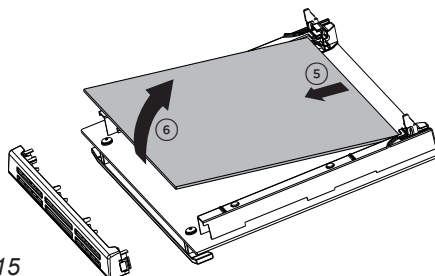

Fig. 8.15

After cleaning replace the door glass panes

When replacing the glass panes make sure that:

- you replace the inner pane correctly as shown. The pane must be in the position described below in order to fit into the door and to ensure that the oven operates safely and correctly;
- you take extra care not to bump the edges of the glass against any object or surface you do not force any of the panes into place. If you are experiencing difficulties replacing the panes, remove them and start the process again from the beginning. If this still does not help, call Customer Care.

Replace the middle pane (some models only)

Ensure the pane is the right way up (the warning text should be readable back to front when the pane is fitted correctly).

- Slot the bottom of the pane into the lower notch at the bottom of the door.
- Position the pane by gently lowering it.

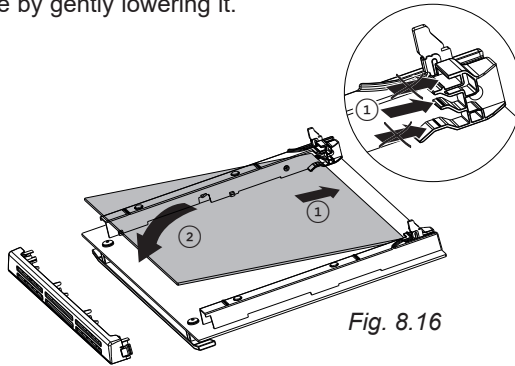

Fig. 8.16

Replace the inner pane

Make sure you fit the glass the right way up, with the bevelled top corner in the correct position.

- Slot the bottom of the pane into the lower notch at the bottom of the door.
- Position the pane by gently lowering it.
- Slide the glass retainer back into place and ensure it is fully clipped securely in place.

Important!

Make sure the glass retainer is correctly and firmly in place and the glass pane is secure.

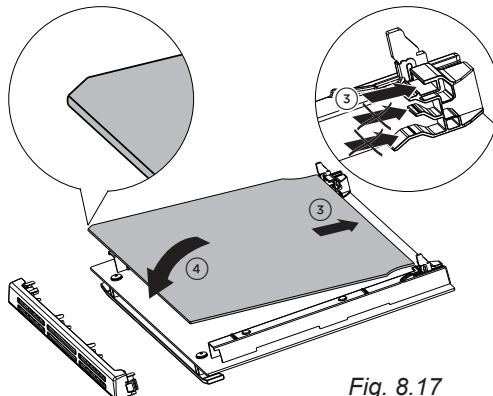

Fig. 8.17

The manufacturer cannot be held responsible for possible inaccuracies due to printing or transcription errors in the present booklet.

The manufacturer reserves the right to make all modifications to its products deemed necessary for manufacturer commercial reasons at any moment and without prior notice, without jeopardising the essential functional and safety characteristics of the appliances.

www.elba-cookers.com

ELBA

TALENT FOR COOKING

 Made in Italy 